

Science, **T**echnology, **E**ngineering, and **M**ath offer broad career pathways into the high-growth industries competing in the global marketplace. The jobs in these areas are offered by businesses on the frontline of technological discovery. With a solid background in STEM, you'll be following a career path that will offer the opportunity to participate in the development of high-demand and emerging technologies.

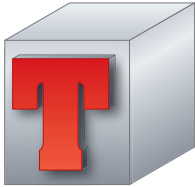

With advances in science driving innovations in technology, materials and procedures researched in the lab are now the backbone of many new processes. Science is used in the design of cell phone circuits, the construction of surfboards, and the processing of food products. While science begins with careful observation, research, and experimentation, it involves more than lab work. Some opportunities will take you into the field. You might also be involved in quality control or technical writing. The range of science career opportunities is extremely large.



Technology joins science skills with those in engineering and math. It is essential in managing communication and information systems. In manufacturing, technology is used to focus human resources and materials in the production of products ranging from electronic devices to footwear. If you want a career that combines science, math, and engineering, consider a career in technology. In that field, you'll work closely with individuals who have a hands-on knowledge of these subjects. As part of their team, you'll help make the decisions needed to bring a product from design through manufacturing to market.



A career in engineering will involve you in the technological innovations that flow from discoveries in science and math. You'll be incorporating these new discoveries in products that expand our technological reach in many areas, including communications. If you think that engineering is unexciting, name a product or service of interest to you that was introduced within the last year. Then identify the main benefit of that product or service. That benefit probably resulted from an engineering effort that built on developments in science, technology, and math. A career in engineering could place you in a position to participate in the development of such products and services.



Math input is essential to product creation and development—whether the product is real, such as a DVD, or virtual, such as an online video game. If you want to be a valued member of the teams providing the math input for the development of products, you will need solid math skills. You'll need these skills for high-level problem solving and innovation. As you advance along the career pathway, you'll be challenged to apply mathematics to real-world problems. There is a wide variety of math careers from which to choose.

SCIENCE

Machines

Although machines make work easier, they don't actually reduce the amount of work that has to be done. How, then, do machines help us? Recall the formula for work:

$$\text{Work} = \text{force} \times \text{distance}$$

In this equation, if you increase the force, you can decrease the distance and still do the

same amount of work. If you increase the distance, you can decrease the force. Machines help us by increasing distance, increasing force, or changing the direction of force. Complicated machines are combinations of a few basic machines. These basic machines are shown and described below.

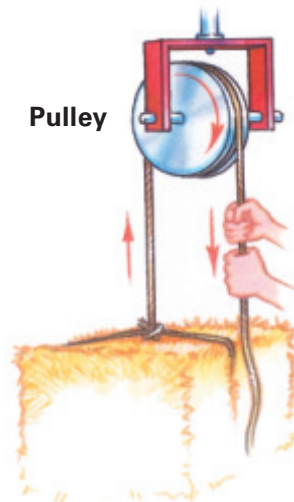
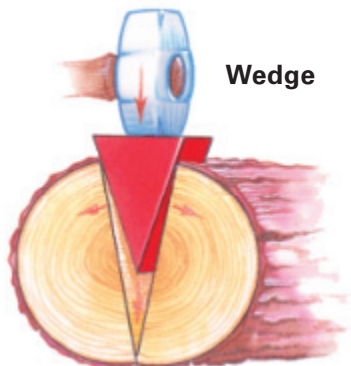
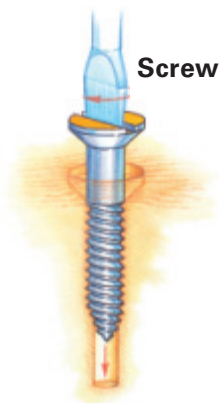
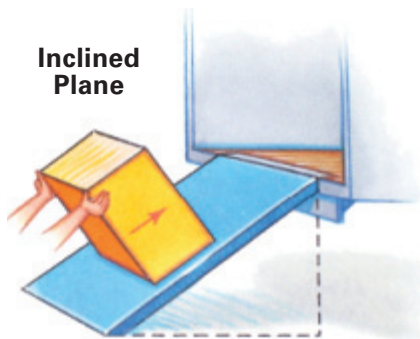
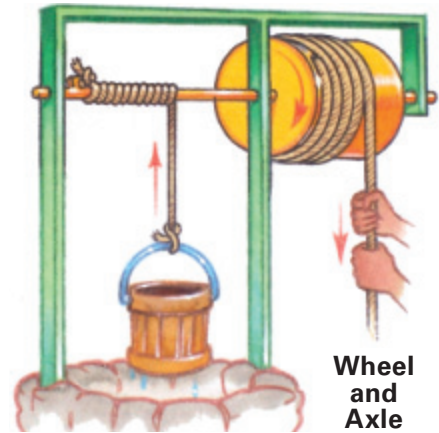
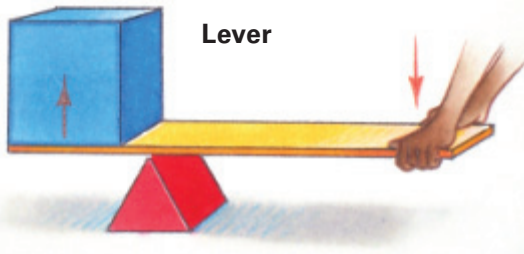

Mechanical Advantage

Some machines are more helpful than others. The measure by which a machine increases force is known as its mechanical advantage (MA). This can be calculated by the formula:

$$MA = \frac{F_r}{F_e}$$

In this equation, F_r stands for resistance force (load). This is the force applied by the machine. For example, a screwdriver exerts a force on a screw. F_e stands for effort force, the force applied to the machine. An example is the force you apply to the screwdriver. If a small effort force results in a large resistance force, the machine has a high mechanical advantage. The greater the mechanical advantage, the more helpful the machine.

For machines that increase distance, we can calculate velocity ratio. The velocity ratio is the distance the load moves divided by the distance the effort moves.

Efficiency

Efficiency compares the work a machine can do with the effort put into the machine. The energy output of a machine is always less than the energy input. That's because some of the energy input is used to overcome friction between moving parts. Efficiency is usually stated as a percentage. Machines with a higher percentage are more efficient.

$$\text{Efficiency} = \frac{\text{work output}}{\text{work input}} \times 100\%$$

What if you applied all of a machine's energy output to the machine itself? Is it possible to build a perpetual motion machine—a machine that will run forever? Unfortunately, no. All machines need a con-

tinuous outside supply of energy. If no energy is brought into the system, the machine will eventually stop. Also, all machines use more energy than they output. No machine is 100 percent efficient.

Power

Power is work done within a certain period of time. To calculate power, determine the amount of work done. Then divide the amount of work by the time it took to do the work.

$$\text{Power} = \frac{\text{work}}{\text{time}}$$

Gears and Cams

Gears are intermeshing toothed wheels and bars that transmit force and motion. They can alter the force's size and the motion's speed and direction. A cam is an offset wheel. Cams are connected to rods. A second rod, or follower, rests on the top of the cam. As the cam turns, the top rod moves up-and-down.

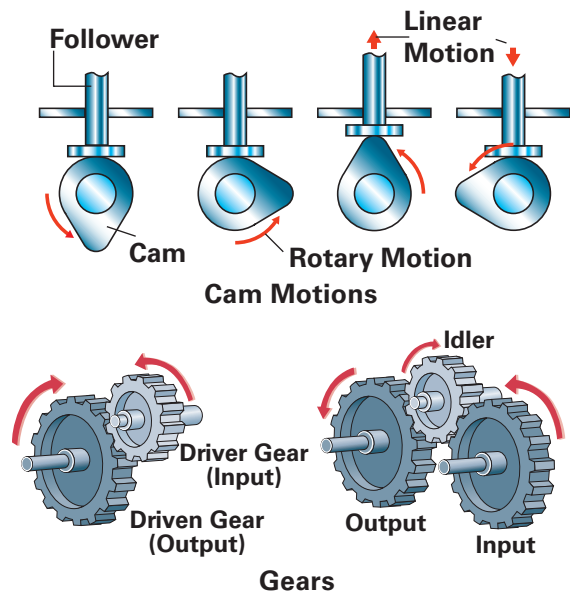

Forces and Motion

A force is a push or a pull. Forces are everywhere. The force of gravity keeps your feet on the ground. Motion takes place when a force causes an object to move. Think about machines. They make work easier by applying or changing forces.

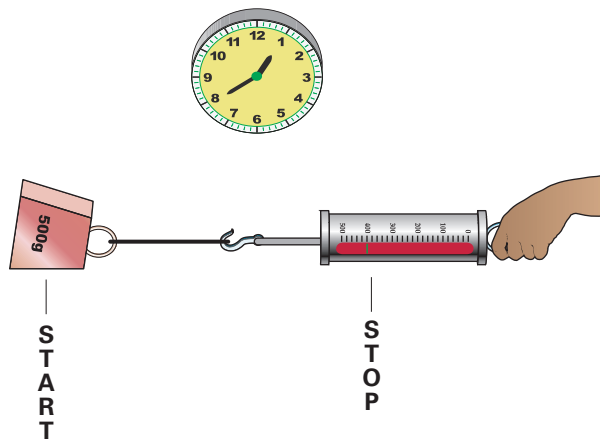

Basic Physical Forces

The four basic physical forces in the universe are gravity, electromagnetism, the strong nuclear force, and the weak nuclear force. You are already familiar with gravity and electromagnetism. The strong nuclear force holds the nuclei of atoms together. The weak nuclear force involves radioactivity and particle decay.

I feel it in my GUT . . .

Scientists have already proven that two of the forces—electromagnetic and weak nuclear—are different aspects of one force, called the electroweak force. Now they're working to prove the theory that gravity and the strong nuclear force are also related to the electroweak force. This theory is called the Grand Unified Theory, or GUT.

Forces can act from a distance, without objects touching one another. Earth's gravity affects the moon, even though the moon is nearly 250,000 miles away. The moon's gravity also affects the earth, causing the tides.

The "weightlessness" of astronauts as they orbit the earth in the space shuttle is not the result of their distance from the earth. The astronauts float because they are falling toward the earth at the same rate as the shuttle. However, the shuttle is also moving forward at a fast speed. This forward motion, combined with the downward pull of gravity, keeps the shuttle in a circular path around the earth.

Gravity

Gravity is a force that pulls objects toward each other. Gravity increases as mass (amount of matter) increases. Gravity decreases as distance increases.

Weight is the amount of force exerted on matter by gravity. While mass remains constant, weight varies, depending on the amount of gravitational attraction. For example, gravity on the moon is only one-sixth of that on Earth.

Terminal Velocity

Gravity accelerates a falling object at the rate of 32.2 feet per second, per second. Does that mean an object will just keep falling faster and faster? No, because the object encounters air resistance. As the object falls faster, air resistance increases. Eventually, the air resistance equals the force of gravity. The object then falls at a steady speed. This speed is the object's terminal velocity.

Pressure

Pressure is the weight (force) acting on a unit of area. When your *Technology: Engineering & Design* textbook is flat on your desk, it exerts pressure on the desktop. The book covers an area of approximately 80 square inches. It weighs about 2.75 pounds. To calculate how much pressure the book exerts on the desktop, use this formula:

$$\text{Pressure} = \frac{\text{force}}{\text{area on which the force acts}}$$

The book exerts 0.034 pounds of pressure per square inch. If you place the book upright, it will touch 8 square inches of the desktop. How much pressure per square inch will it exert?

Can you see that concentrating force on a smaller area increases the pressure per square inch? How might this knowledge help you if you were designing a machine and wanted to get a lot of pressure from a small force? What if you were designing a building? Would you want the force concentrated or spread out?

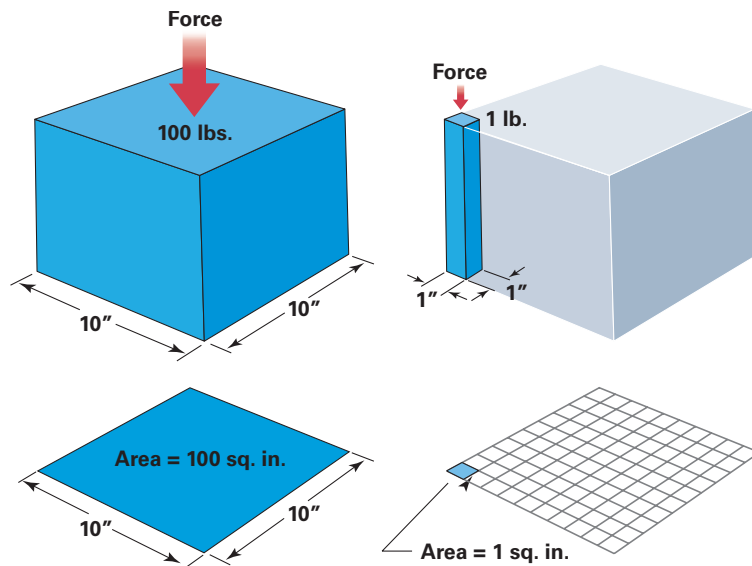

Vectors

What happens when two or more forces act on an object at the same time? When the forces are balanced, they cancel each other out. There's no change. When forces are unbalanced, there's change in movement.

A vector is a mathematical expression of a force. Forces can be expressed mathematically as vectors. A vector has a direction and size. When two vectors are combined, the result is called the resultant. To find the resultant of two forces acting at an angle to each other, draw two lines to represent the size and direction of the two forces. (You'll need to draw the lines to scale and at the correct angle to each other.) Next, draw two lines parallel to these. You've drawn a parallelogram. The diagonal of this parallelogram represents the size and direction of the resultant.

Newton's Laws of Motion

In the seventeenth century, the English scientist Isaac Newton described three laws of motion.

Newton's First Law Sometimes called the “law of inertia,” Newton’s first law states that an object at rest will stay at rest unless a force acts on it. If an object is in motion, it will stay in motion unless a force acts on it. For example, have you ever noticed that when riding in a car that stops quickly, your body will continue to move forward and tighten up against the seatbelt? This is because your body is trying to stay in motion, but the force of the seatbelt is stopping you. The car, too, is trying to stay in motion, but the force on the brakes is slowing it down.



Newton's Second Law When a force acts on an object, the result is a change in speed or direction. The object will start to move, speed up, slow down, or change direction. The greater the force, the greater the change. For example, if you and a friend push on a stalled car, the car will move. Once the car begins to move, the harder you push, the faster the car will go.



Newton's Third Law For every action, there is an equal and opposite reaction. For example, when you bounce on a trampoline, you exert a downward force on the trampoline. The trampoline then exerts an equal force upward, sending you into the air.



Speed, Velocity, and Acceleration

Speed, velocity, and acceleration are related, but each is distinct.

Speed is a measure of how fast an object is moving.

Velocity is the speed of an object in a certain direction. The velocity of a car on the highway might be 65 miles per hour. If the car moves onto an exit ramp, there is a change in velocity.

A change in velocity is called acceleration. The greater the mass of an object, the greater the force needed to accelerate it. If the change is a decrease in speed, it is negative acceleration, or deceleration.

Forces and Fluids

Hydraulics is a branch of science that deals with the motion of liquids. Aerodynamics deals with the motion of gases. Liquids and gases are fluids—substances that can flow. The properties of fluids make them well suited for certain technological applications.

Force, Mass, and Acceleration

Force (a push or pull) causes a mass (amount of matter) to accelerate (change speed and/or direction). The formula for finding force is:

$$\text{Force} = \text{mass} \times \text{acceleration}$$

In the metric system, force is measured in newtons (named for Isaac Newton). Mass is measured in kilograms. Acceleration is measured in meters per second, per second. In other words:

$$\text{Newtons} = \text{kilogram} \times \frac{\text{meter}}{\text{second}^2}$$

In the customary system, force is measured in pounds. Acceleration is measured in feet/second². The unit of mass is the slug. One slug equals 14.6 kilograms.

- When a force is applied to a confined fluid, the pressure is transmitted throughout the fluid (Pascal's principle).
- Pressure increases with depth.

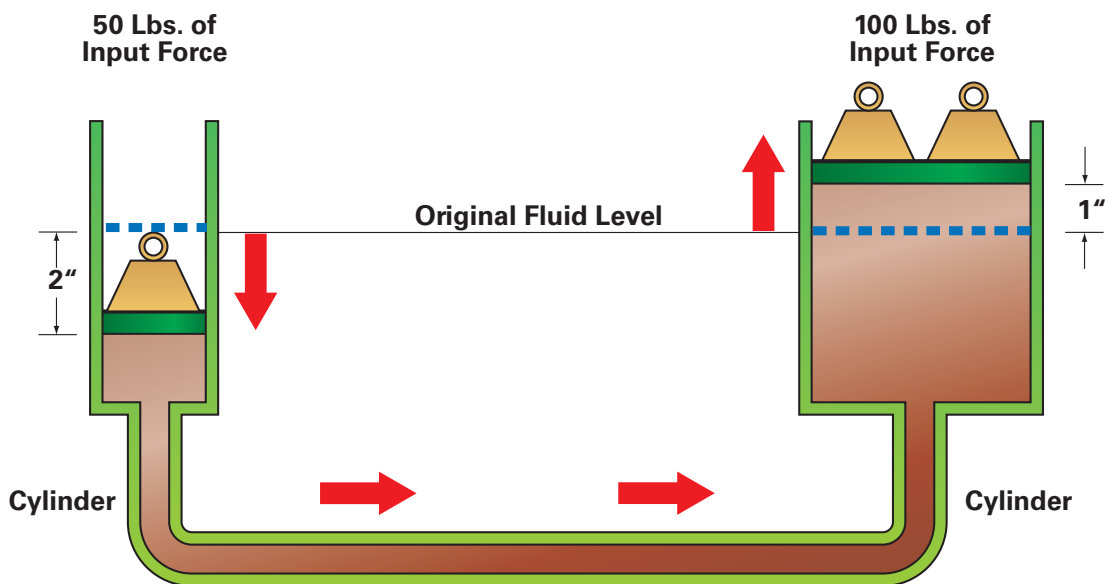

- A fast-moving fluid has a lower pressure than a slow-moving fluid (Bernoulli's principle). That's why airplanes can fly. The air moves faster above the wings than below them. The difference in air pressure enables the airplane to stay aloft.



Air flows faster—
lower air pressure.

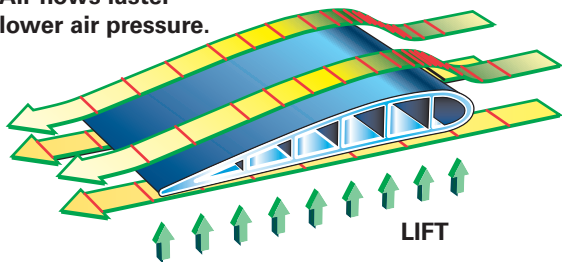

Air flows slower—
greater air pressure.

Energy and Work

Potential and Kinetic Energy

Energy is the ability to do work. Although it can take many forms, there really are only two kinds of energy: kinetic and potential. Kinetic energy is energy in motion. Potential energy is energy at rest.

Consider what happens when you use a hammer to drive a nail. As you lift the hammer, you do work. You exert force that moves an object over a distance. Some of your energy is transferred to the hammer. That energy is stored in the hammer as potential energy. When you move the hammer towards the nail, the potential energy becomes kinetic energy. When the hammer head hits the nail, energy is transferred from the hammer to the nail. The hammer stops, but the nail moves.

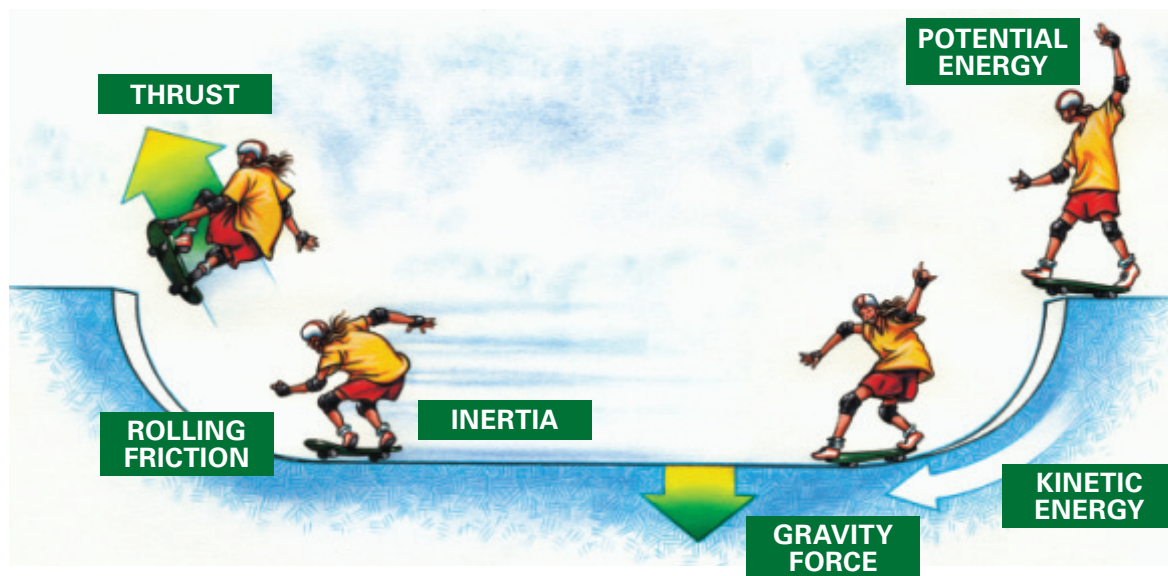

Copyright © by The McGraw-Hill Companies, Inc. All rights reserved.

Measuring Kinetic Energy

The kinetic energy (ek) of a moving object is found by using the formula:

$$E_k = \frac{1}{2}mv^2$$

In this formula, m is the mass of the object, in kilograms, and v is the velocity in meters per second.

From this formula, you can see that kinetic energy increases with the mass and speed of a moving object. An object with twice the mass has twice the kinetic energy. An object with twice the speed has four times the kinetic energy. That's why automobile accidents at high speeds cause more damage. There is more kinetic energy.

Types of Potential Energy

Potential energy is the energy an object has because of its position or condition.

- Gravitational potential energy is stored when work lifts an object against the force of gravity, as in the example of lifting the hammer.
- Elastic potential energy is stored when work twists or stretches an object or changes its shape. A stretched rubber band is an example of stored elastic energy.
- Electrical potential energy is the stored energy of electric charges.
- Magnetic potential energy is the stored energy of a piece of iron near a magnet.

Conservation of Energy

Energy does not disappear. The total amount of energy stays the same. This principle is known as the conservation of energy. It states that energy cannot be destroyed. However, energy can change form. It can move from object to object.

Converting Mass to Energy

Can energy be created? Albert Einstein showed that, in a nuclear reaction, some mass is converted to energy.

$$E = mc^2$$

In this formula, E is energy, m is mass, and c is the speed of light. Since the speed of light is 300,000 kilometers per second, you can see that even a small amount of mass can release a huge amount of energy.

Forms and Uses of Energy

Technology converts energy from one form to another to accomplish work. Here are a few examples.

- Chemical energy stored in a flashlight battery is converted into light and heat energy.
- Mechanical energy (movement of objects) is converted to electrical energy by generators.
- Heat energy from the earth is converted to electrical energy in geothermal power plants.
- Light energy is converted to electrical energy in a solar cell.

- Sound (a type of mechanical energy) is converted to electrical energy in a telephone transmitter. At the other end of the line, it is converted back to sound.
- Electrical energy is converted to sound and light in a television set.
- Nuclear energy is released when the nuclei of atoms are split. This splitting, or fission, yields large amounts of heat energy that nuclear power plants convert to electricity. Nuclear energy is the strongest known force. If you could release the nuclear energy in 1 kilogram [2.2 pounds] of coal, you'd have the energy obtained from burning 3 million kilograms [6.6 million pounds] of coal.

Work

When a force acts on an object and moves that object in the same direction as the force, then work has been done. Work involves a transfer of energy. For example, energy from gasoline or diesel fuel is transferred through a car's engine to the wheels. The car moves.

It's important to remember that work involves both force and motion. If applying a force does not result in motion, then no work has been done. Also, the motion must be in the direction of the force.

Measuring Work

The amount of work done is found by multiplying force times distance.

$$W = f \times d$$

In the metric system, force can be expressed in newtons and distance in meters. The unit for work is the newton-meter, or joule. One joule is equal to the work done when a force of one newton

moves something a distance of one meter in the direction of the force.

Several kinds of units are used for measuring energy and work. The units used depend on the amount of work being measured. You've already learned about the joule. Other units are the erg, electronvolt, calorie, Btu, and foot-pound.

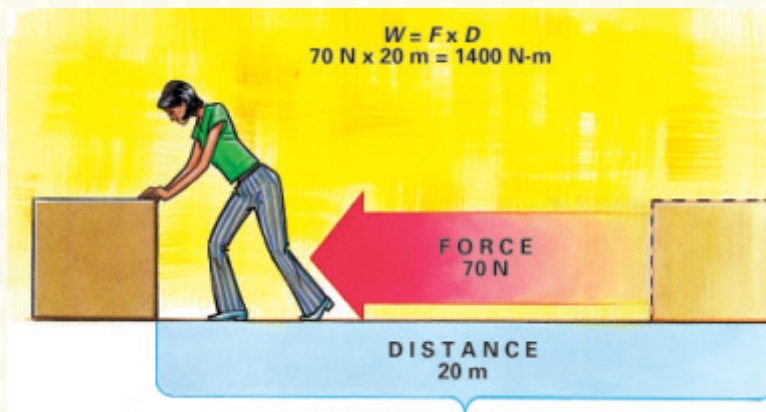

Matter

Our world consists of energy and matter. Energy is the ability to do work. Matter is what energy does work on. Matter is the “stuff” that things are made of. Anything that takes up space, has mass, and is made of atoms—whether it’s wallboard or water vapor—is made of matter.

An atom is the smallest unit of matter, so small that trillions of atoms fit on a pencil point. An atom has a positively charged core called the nucleus and one or more negatively charged electrons. These orbit the nucleus (opposites attract, as with the poles of a magnet). However, electrons also respond to nearby atoms to form bonds that define the matter we know and work with.

For example, atoms may donate electrons to neighboring atoms. The steel-blunting hardness of quartz comes from this kind of bond. Plastics, on the other hand, are built on electron-sharing (covalent) bonds. Metals have their own system-wide form of electron sharing, known as the metallic bond. All these bonds, involving attraction of electrons to neighboring atoms, are chemical bonds.

Mass and Density

Mass is the measure of the amount of matter in an object. It is measured in kilograms. Density is a measure of mass per unit of volume. Put simply, if mass is a measure of how much “stuff” there is in an object, density is a measure of how tightly that “stuff” is packed.

Archimedes’ Principle

Archimedes was a Greek mathematician. He discovered the law of buoyancy, which is sometimes called Archimedes’ principle.

This law states that the buoyant force on a completely or partially submerged object always equals the weight of the displaced fluid.

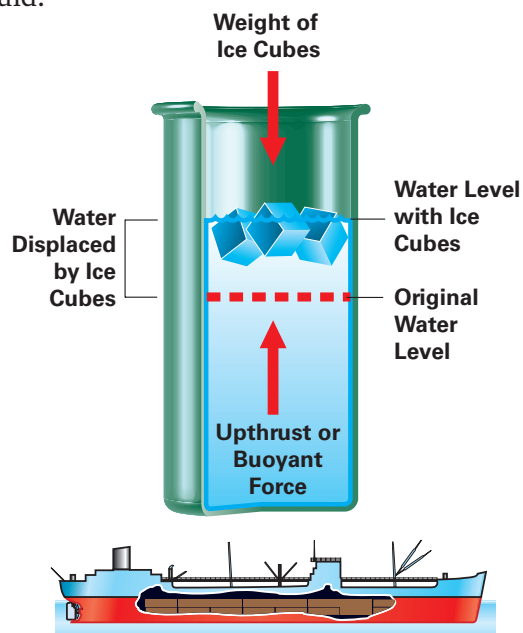

Elements

An element is a substance containing only one kind of atom. One kind of atom differs from another according to its number of protons, particles in the nucleus that give the nucleus its positive charge. An atom of hydrogen (H) has one proton. Helium (He) has two protons.

Compounds

Elements exist in pure form, such as pure oxygen. More often, elements combine with other elements to form another substance that may be quite different from its ingredients. For example, two gases (hydrogen and oxygen) combine to form water, a liquid. A substance that combines two or more elements in specific proportions is called a compound.

The specific proportions determine how two or more elements will bond and how the resulting compound will behave. Two atoms of hydrogen combine with one atom of oxygen to form water (H_2O). Two hydrogen atoms combine with two oxygen atoms to form hydrogen peroxide (H_2O_2). This is a bleaching agent that has been used as rocket fuel.

The proportions affect the arrangement assumed by the atoms in a compound. An interlocking-matrix arrangement gives hardness to glass and other ceramics. A long, chainlike arrangement gives plastics the capacity to be re-shaped. Certain solvents have a ring arrangement of carbon and hydrogen.

Elements can combine in many ways—forming different kinds of chemical bonds and different arrangements of atoms. Millions of compounds are available.

Mixtures

A mixture is a combination of elements or compounds that does not involve a chemical bond. In other words, the ingredients hold onto their atomic identity. As a result, the ingredients of a mixture can be separated and recovered by ordinary mechanical means. These include filtering, settling, and distilling.

The ingredients in a mixture generally keep their characteristics. Sugar dissolved in water, for example, is both wet and sweet even though the sugar disappears from sight.

An alloy is a mixture made by mixing two or more pure metals or by mixing metals with nonmetals. The mixture is stronger than pure metal. For example, mixing small amounts of carbon with iron makes steel.

Differences between compounds and mixtures include the following:

- Mixtures can be separated mechanically. Separating a compound requires breaking chemical bonds.
- In a mixture, ingredients keep their original properties.
- In a mixture, the proportion of ingredients does not have to be exact. Brass, for example, may have varying amounts of copper and zinc.

Properties of Materials

Designers, engineers, and builders must know the properties of materials in order to select the right ones for the job. Materials have many properties. The following explanations and drawings describe common properties.

- Sensory properties are those we can see, hear, smell, taste, or feel. Colors may be used to please the eye or to grab attention. Materials for blankets and infants' clothes are chosen for their softness. Scents are added to cleaning products to emit fresh, clean odors.
- Optical properties determine how a material reacts to light. Window glass is transparent—light passes through it and you can see through it clearly. Frosted glass is translucent—light passes through it, but you cannot see through it. Opaque materials do not allow light to pass through. Some opaque materials, such as aluminum foil, also reflect light.
- Thermal properties determine how a material reacts to heat. Most metals are good heat conductors. This is why pots and pans are frequently made of metal. Fiberglass

Ductility—the ability to be formed and reformed.

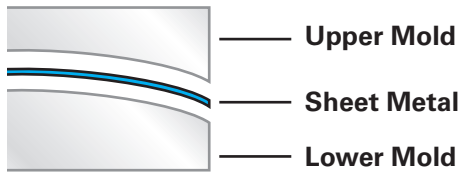

Elasticity—the ability to return to original shape after being pulled or pushed.

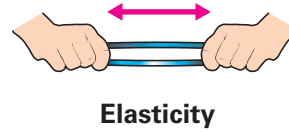

Hardness—the ability to resist denting and scratching.

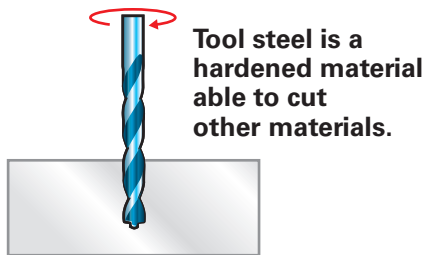

Conductivity—the ability to allow the flow of heat or electricity.

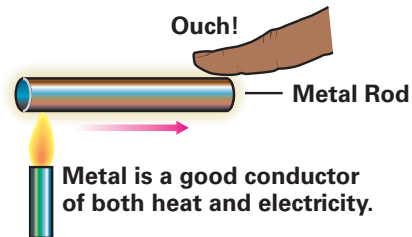

Strength—the ability to resist forces such as tension and compression.

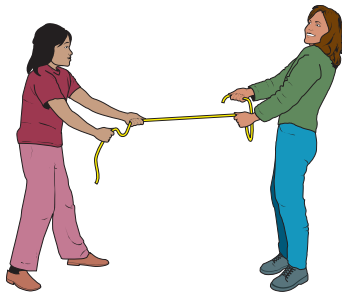

Tensile Strength

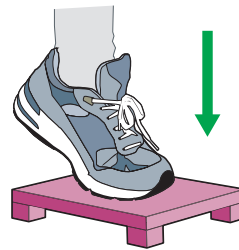

Compressive Strength

Copyright © by The McGraw-Hill Companies, Inc. All rights reserved.

- and Styrofoam™ resist the flow of heat. Therefore, these materials are commonly used to insulate structures and products.
- Electrical properties determine whether a material is a conductor, an insulator, or something in between (a semiconductor). Copper is a good electrical conductor, so it is frequently used in electrical wiring. Rubber blocks the flow of electricity. It is

frequently used to cover the copper wire in electrical cords for safety.

- Magnetic properties determine how a material reacts to a magnet.
- Chemical properties deal with things such as whether a material will rust or whether it can dissolve other materials.
- Mechanical properties are those that describe how a material reacts to forces.

Electricity and Magnetism

Electricity

Electricity exists because most elementary particles of matter (such as electrons and protons) have a negative or positive charge. Like charges (two positives or two negatives) repel each other. Unlike charges attract. This electrical force is responsible for many natural phenomena. Technology has found many uses for it.

Electricity can be classified as static or current. In static electricity, the charges are “at rest.” They remain in certain positions on objects. Static electric charges can build up when two different materials rub together, as when you walk on a carpet. If you then touch metal, the built-up charges suddenly flow away. They are no longer static, and you feel a shock. Lightning is another example of the sudden discharge (flowing away) of static electricity.

A flow of electricity is a current. A material through which current flows easily is called a conductor. A material through which almost no electricity can flow is called an insulator. Some materials can behave either as conductors or insulators, depending on what other materials are mixed with them. These are called semiconductors. They can be used to control the flow of electricity. For example, semiconductors are used to make computer chips.

Series and Parallel Circuits

The path electricity takes as it flows is called a circuit.

In a series circuit, individual components are connected end to end to form a single path for current flow. Series circuits have two major disadvantages. First, when con-

nected in series, each circuit has to have its own switch and protective device. Also, if one component is open, the entire circuit is disabled.

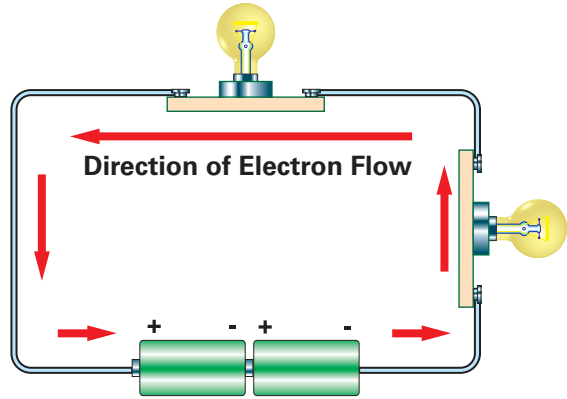

Series Circuit

In a parallel circuit, two or more loads are connected in separate branches. In most cases the parallel circuits are connected in series with a common switch and protective device. Equal voltage is applied to each

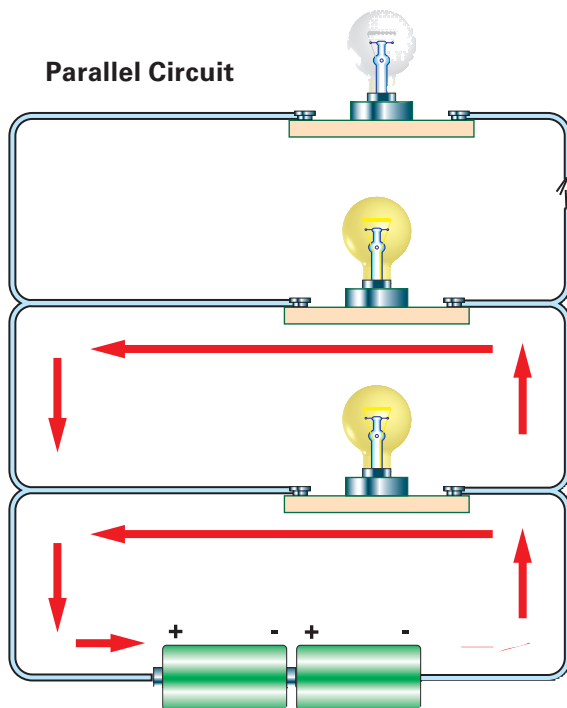

Parallel Circuit

branch of a parallel circuit. Current flow divides as it reaches the parallel path. The amount of current flowing through each branch depends on the resistance in that path only.

A flashlight has a simple circuit. Turning on the switch completes the circuit. This allows electricity to flow from the battery, through the switch, then through the bulb and back to the battery.

Ohm's Law

Current is the amount of charge that flows past a point in a circuit during a given time. Current is measured in amperes (A).

For a current to exist in a conductor, there must be an electromotive force (emf), or potential difference, between the two ends of a conductor. This electromotive force is measured in volts (V).

Even conductors resist the flow of current somewhat. The greater the resistance, the less current that flows. Resistance is measured in ohms (Ω).

The voltage, amperage, or resistance of an electrical circuit can be calculated by using

Ohm's law (named for German physicist George S. Ohm). This law states that electric current equals the ratio of voltage and resistance.

$$I = E/R$$

In this formula, I stands for the intensity of the current, measured in amperes; E stands for electromotive force, measured in volts; and R stands for resistance, measured in ohms.

Magnetism

A pole is an area where magnetic density is concentrated. All magnets have two poles. These are designated as the north and south poles. The north pole of one magnet will attract the south pole of another magnet, while it will repel the other magnet's north pole.

Around the magnet is an invisible force field. When certain materials, such as iron, enter this force field, they become magnets, at least temporarily.

The planet Earth is a magnet with a force field extending into space. The force field, called the magnetosphere, protects us from harmful solar radiation. The poles of the earth magnet are not in exactly the same place as the geographic poles.

There is a scientific explanation for the action of magnets. Atoms produce magnetic fields. The magnetic field around a single atom is very weak. If the magnetic fields of a group of atoms align (point in the same direction), the force is much stronger. Such a group of atoms is called a domain. If the domains in a material align, that material becomes a magnet.

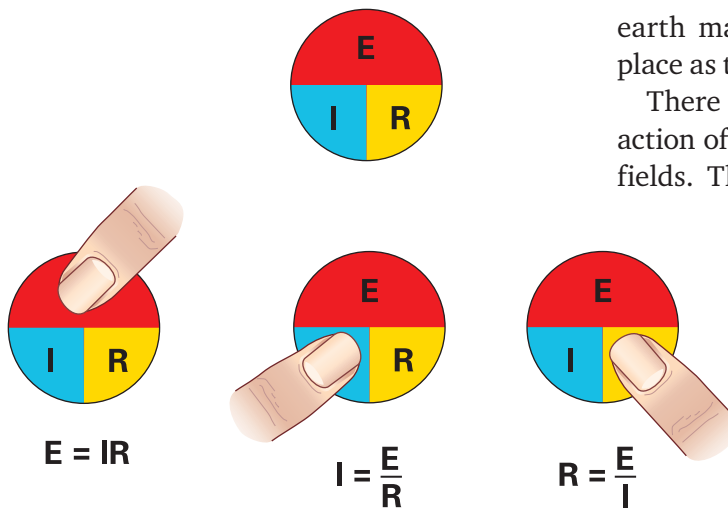

Electromagnetism

Magnets are not the only source of magnetic fields. Electric currents also produce magnetic fields. Magnetism produced by electricity is called electromagnetism. A magnet created by electricity is called an electromagnet. Electromagnets are very useful in many devices. Unlike other magnets, they are easily turned on and off. Their strength can be controlled by controlling the strength of the current.

Uses for Electricity and Magnetism

The relationship of electricity to magnetism has led to many developments in technology.

- Electromagnets make possible the magnetic levitation in maglev trains.
- A magnetic resonance imaging (MRI) machine contains a large coil that creates a strong magnetic field. This magnetic field affects the atoms in the human body. The machine detects the patterns of energy absorption.
- The electric current used in most homes and businesses is produced by generators at a power plant. Generators use magnets to convert the energy of motion (from steam, falling water, or wind) into electricity.
- Electric motors use magnets to change electricity into motion. They work by the interaction of a permanent magnet and an electrically induced magnetic coil.
- Computers, VCRs, and tape players make use of magnetic tapes and disks. Recording heads change electrical signals into magnetic patterns on the tape or disk. On playback, the process is reversed.

Light

Light is a form of energy. Sometimes it behaves like waves, sometimes like a stream of particles. The study of light has helped us develop technologies that make use of light as energy.

Properties of Light

Light travels in waves. The behavior of light waves is similar to the behavior of sound or water waves. For example, light waves bend as they pass through a small opening and spread out on the other side of the opening. This behavior is called diffraction. However, unlike water or sound waves, light waves can travel through a vacuum (an absence of air).

The speed of light is 300,000 kilometers [186,000 miles] per second in a vacuum. It travels at slower speeds through air, water, glass, or other transparent materials. When moving through an empty vacuum, light travels in a straight line. When it meets an object, the light may reflect (bounce off), be absorbed, or be transmitted (travel through).

Index of Refraction

As you've read, the speed of light changes when it passes from one medium (such as air) into another (such as glass). The index of refraction expresses the relationship between the two speeds. In the example of the glass, the index of refraction would be the speed of light in air divided by the speed of light in glass. Most glass has a refractive index of 1.5 compared with air. This means light travels 1.5 times faster in air than in glass.

Light and the Electromagnetic Spectrum

A vibrating electric charge produces an electric field. The electric field produces a magnetic field. The magnetic field produces an electric field, which produces a magnetic field, and so on. This combination of constantly changing electric and magnetic fields is called an electromagnetic wave. Wave properties include frequency, speed, amplitude, length, and direction.

Frequency is the number of waves that pass a given point in one second. Amplitude is the strength (or height) of a wave.

Speed is the frequency times the wavelength. The speed of all electromagnetic waves is the same. Waves of higher frequency have shorter lengths. Waves of lower frequency have longer lengths.

Visible light is a type of electromagnetic wave and part of the electromagnetic spectrum. This spectrum is a range of wavelengths that also includes radio and television waves, radar (microwaves), infrared rays, ultraviolet rays, X-rays, and gamma rays.

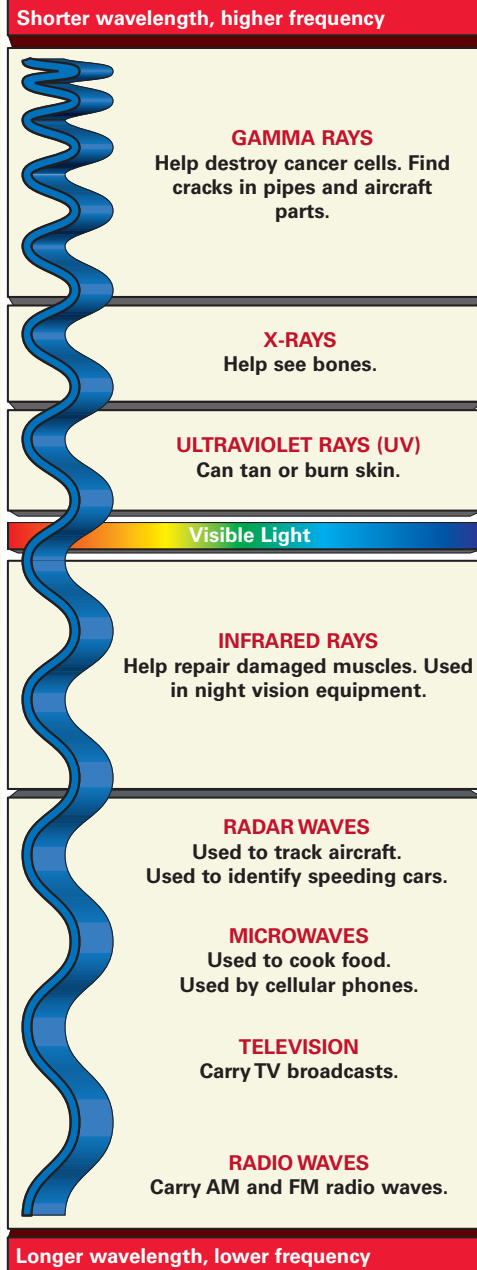

When light passes through a material, it slows down and changes direction. This behavior is called refraction. You can see this effect if you put a straight straw into a glass of water. The straw will appear bent where it enters the water. It's not the straw that has bent, though, but the light.

Lenses

Lenses make use of the fact that light can be refracted. Most lenses are made of glass or transparent plastic and have at least one curved side. They can focus light (make light rays come together) or spread it out.

A divergent lens makes light rays bend away from each other. A divergent lens is thicker at its edges than at its center. The image seen through this lens is upright, smaller than the object, and virtual (located on the same side of the lens as the object). A virtual image cannot be shown on a screen. A real image can.

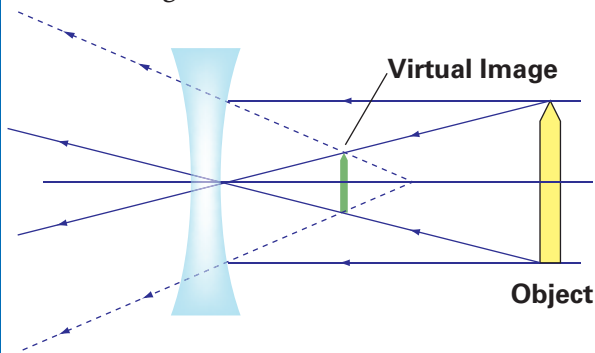

A convergent lens bends light rays toward each other. A convergent lens is thicker at the center than at the edge. The image formed by a convergent lens may be real or virtual, depending on the object's position in relation to the lens.

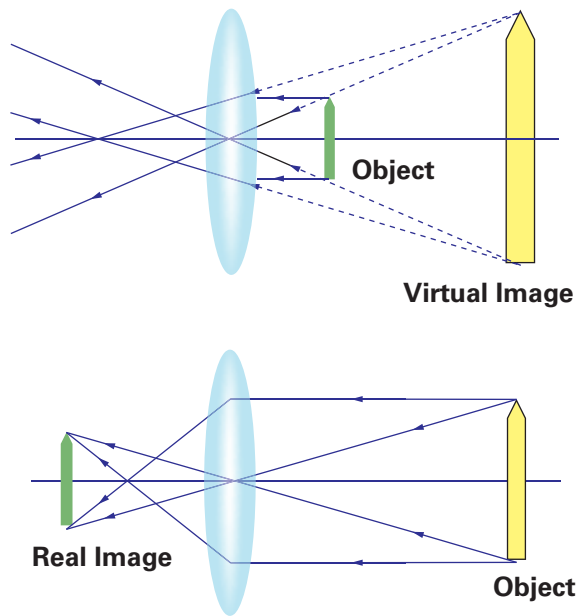

Uses of Light

Light finds various uses in communication and energy production.

- Pulses of light can be transmitted through fiber-optic cables. These pulses can carry telephone conversations, TV signals, or computer data.
- Photography (discussed in Chapter 7) is the control and recording of light. In videophotography, light is recorded as magnetic patterns.
- Photovoltaic cells turn light energy into electrical energy. Some experimental vehicles are solar-powered.
- Lasers produce a very precise beam of light. The light waves are “in step” with each other. Laser uses include surgery and reading compact discs.

Cells

All living things are made of cells. Most cells are microscopic. An egg is an example of a very large cell.

Creatures such as bacteria consist of only one cell. Others are made up of many kinds of cells that have specialized functions. In the human body, for example, hair cells differ from liver cells. Both differ from muscle cells. In a plant, cells that make up the roots differ from the cells in the stalk.

Despite their variety, all cells share certain basic traits. Cells live by taking in food, converting it into energy, and eliminating waste. Cells reproduce by dividing in two. To carry out these functions, cells regulate their chemical reactions.

The chemical reactions that occur inside a cell depend on long, chainlike molecules called proteins. Even the simplest cell contains many different kinds of proteins. Each has a highly specific job to perform. DNA, for example, is a complicated combination of proteins. A technologist can cause a cell to produce something or stop producing something. The tool to make it happen would be a protein.

Plant and animal cells have certain features in common. A double-layered cell membrane made of a lipid (fat) keeps the watery contents of a cell in. It keeps almost everything else out. The membrane is dotted with proteins that act as gatekeepers.

If a substance pushes against a gatekeeper protein and offers the right chemical fit, a passage opens. This is how a cell lets food in and discharges waste.

- Cytoplasm is a gel-like substance that fills the cell. It provides a medium for internal transport of materials.
- The nucleus is the core of the cell, containing its chromosomes. Chromosomes are made of DNA. This provides “templates” for assembling the right chemicals in the right way to carry on the life of the cell. Certain single-celled organisms, such as bacteria, do not have a nucleus.
- Mitochondria are structures (organelles) that provide energy to the cell. They break down nutrients with enzymes.
- Vacuoles are pockets for storing nutrients. Some animal cells do not have vacuoles. They may have other structures for storing materials until they are needed.
- Plant cells have two features not found in animal cells: chloroplasts and a thick cell wall.
- Chloroplasts create energy for plant cells. They use sunlight to convert water and carbon dioxide into simple sugars.
- A thick, fibrous cell wall surrounds the membrane of a plant cell. This provides rigidity to the overall structure of a plant.

TECHNOLOGY

Technology consists of processes and knowledge that people use to extend human abilities and to satisfy human needs and wants. The chapters of this textbook discuss the nature of technology, its effect on our

lives, and the ways technology is used in the designed world.

Technology can be classified into six broad areas.



Communication



Energy & Power



Manufacturing

Copyright © by The McGraw-Hill Companies, Inc. All rights reserved.



Transportation



Construction

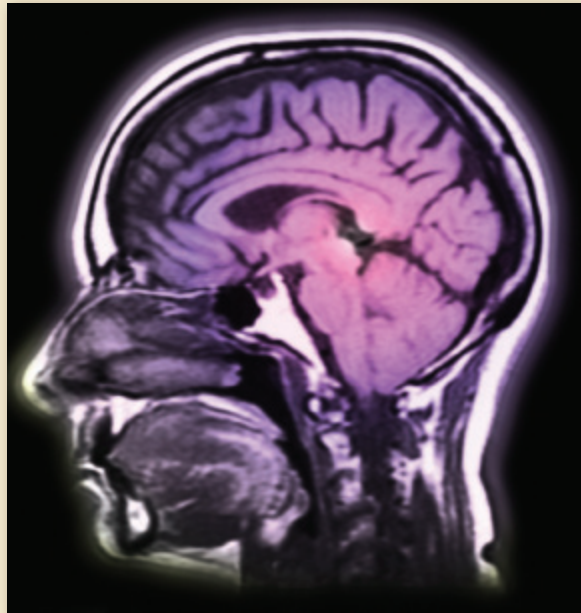

Bio-Related

Copyright © by The McGraw-Hill Companies, Inc. All rights reserved.

ENGINEERING

Design and Drawing for Engineering

Suppose you received the following instructions: “Go north on Route 6. Turn right at Hendricks and park by the pool.” These instructions sound clear enough, don’t they? But we all know that even well-chosen words can prove inadequate. The drawing below, on the other hand, is much clearer.

If you want to be sure someone understands your message, use a picture. As the old saying goes, it is worth a thousand words.

Drawing pictures is a way of “thinking on paper.” Pictures aid problem solving. If you’re not sure whether the jewelry box you’re making would look better with one drawer or two, sketch different designs until you find one you like.



Copyright © by The McGraw-Hill Companies, Inc. All rights reserved.

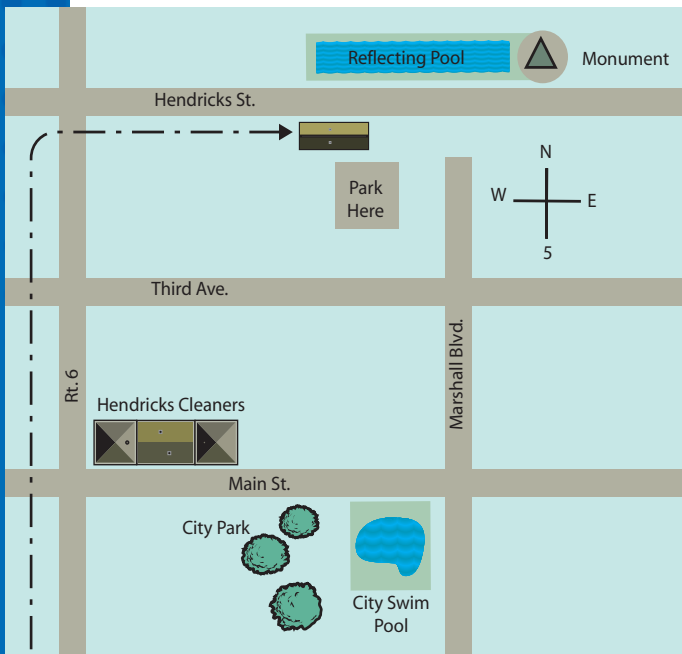

This section of the STEM Handbook will help you use a few graphic methods to communicate and work out solutions to problems. It is not a course in mechanical drawing. However, it will help prepare you for activities in this student text.

If you have access to a CAD system, it is the tool of choice for drafting. Can a computer draw by itself? No. Will it turn a poor student into a good student? No. So what good is it? Perhaps the best thing about CAD is that it allows the user to modify a drawing, just as word processing allows the editing of text. You can cut and paste and save and recall files. You can quickly perform functions that might otherwise take much time and effort.

Sketching

The best way to express yourself graphically when time is short is by sketching. You will rapidly discover what a difficult task interpreting verbal description is. Yet a single sketch may clarify complex thoughts. You can draw “good” sketches by practicing. Few people make attractive sketches at first. Repeated practice over an extended time period, coupled with attention to constructive criticism, is the best approach.

Sketching Tools

The pencils shown here are the different kinds used for drawing. Pencils are classed by the hardness of their lead. Pencils with hard leads are used when accuracy is needed, such as for charts and diagrams. Medium pencils are used for technical drawing and sketching. Soft pencils are used for general artwork and quick sketches.

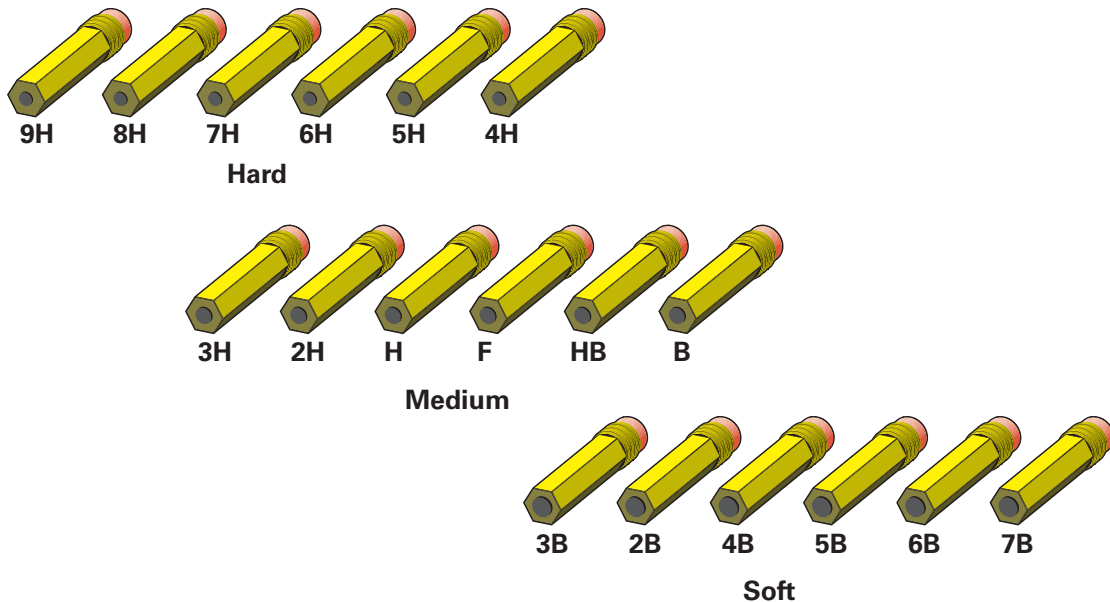

Is It a Good Design?

Before you begin to design a product and during each design stage, ask yourself these questions:

- Is it appropriate to the need you're trying to fill?
- Do people really need it or think they need it? (If they don't, they won't use it.)
- Can it be made under the present conditions? (For example, if you have only a week to make it, can you make it in that time?)
- How much does it cost to make? (If it's too expensive, you'll have trouble marketing it.)
- Is it durable? Will it last?
- Is it attractive?

Use a soft pencil. Hold it about 1½ inches from the point. Work big. Don't make small, cramped pictures. A good sketch should not look stiff and “perfect” like a mechanical drawing. The lines should be free and loose.

When sketching straight lines, spot your beginning and end points (A). Keep your eye on the point toward which you are drawing.

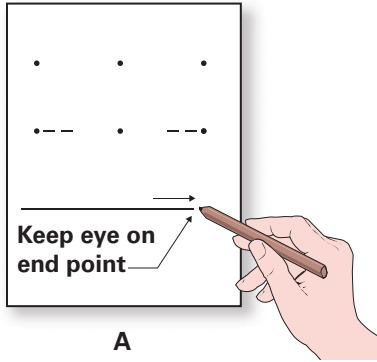

Draw vertical lines downward (B).

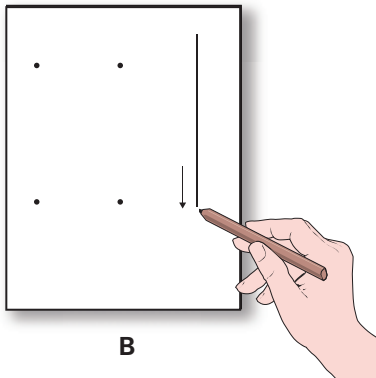

If an inclined line is to be nearly vertical, draw it downward (C and D).

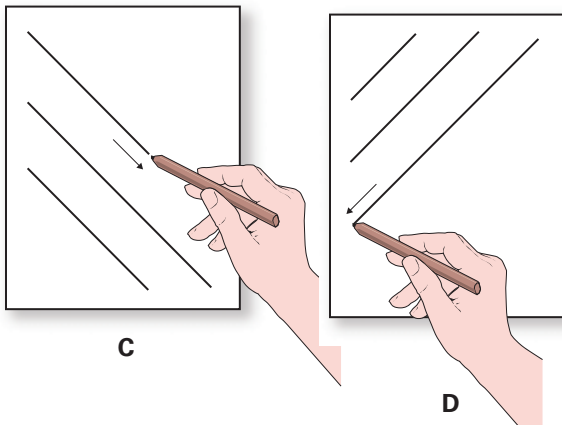

If an inclined line is to be nearly horizontal, draw it to the right (E).

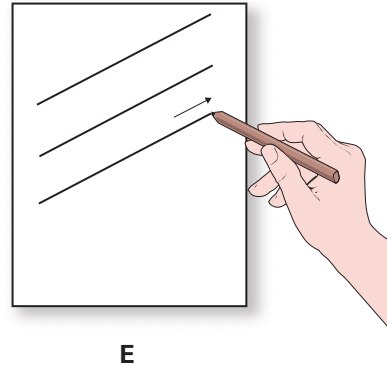

Inclined lines can also be drawn as if they were vertical or horizontal by simply turning the paper (F and G).

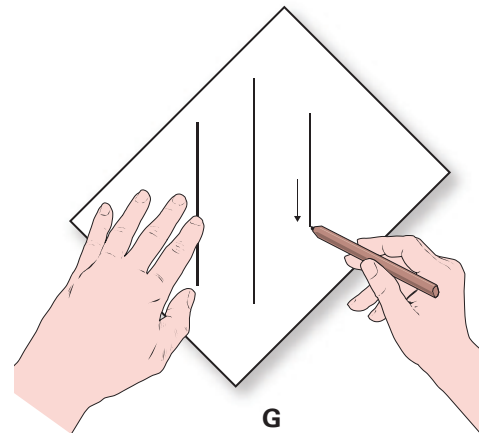
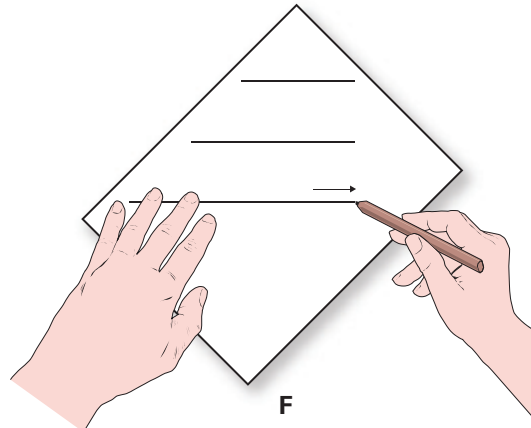

Sketching a Circle

Circles are hard for many people to draw. Many times they are lopsided. There are tricks you can use, however, that make drawing circles easier.

First, lightly sketch a square that is the diameter of your circle (1). Then mark the midpoints of the sides. Next, draw diagonal lines (2) and mark where the line of the circle will cross them. Finally, sketch in the circle (3). (Oval shapes can be drawn the same way, using a rectangle instead of a square.)

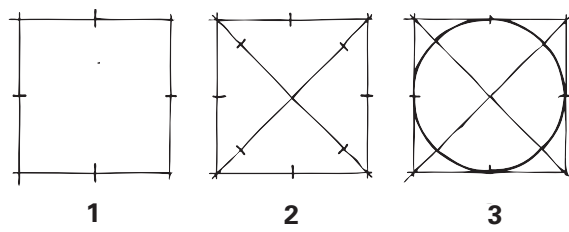

You can also draw a circle with the aid of centerlines. First, sketch two centerlines (1). Then add light radial lines, or “spokes,” between them (2). Make marks where the line of the circle will cross. Finally, sketch in the circle (3).

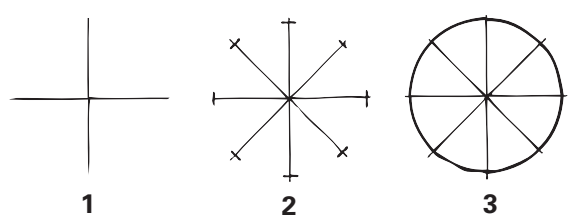

Arcs can be sketched using the same general methods as for circles. First, lightly sketch a square of the same size as the arc. Draw a diagonal line, and mark off the size of the arc. Finally, sketch in the arc itself.

Sketching Practice

These are the steps to follow in making a sketch.

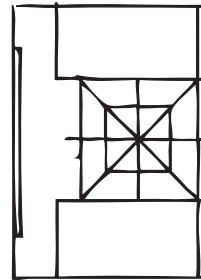

1. Block in main shapes.

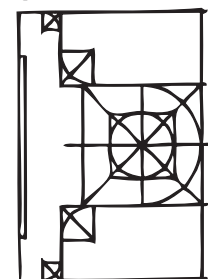

2. Sketch arcs & circles.

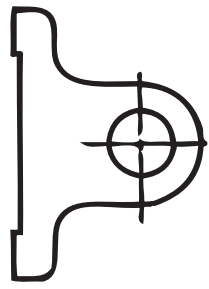

3. Draw heavy final lines.

Copyright © by The McGraw-Hill Companies, Inc. All rights reserved.

Building from Basic Shapes

The square, the rectangle, the circle, the cylinder, the triangle, and the cube can be used to draw other objects. Identify which of them have been used to help create the objects shown here.

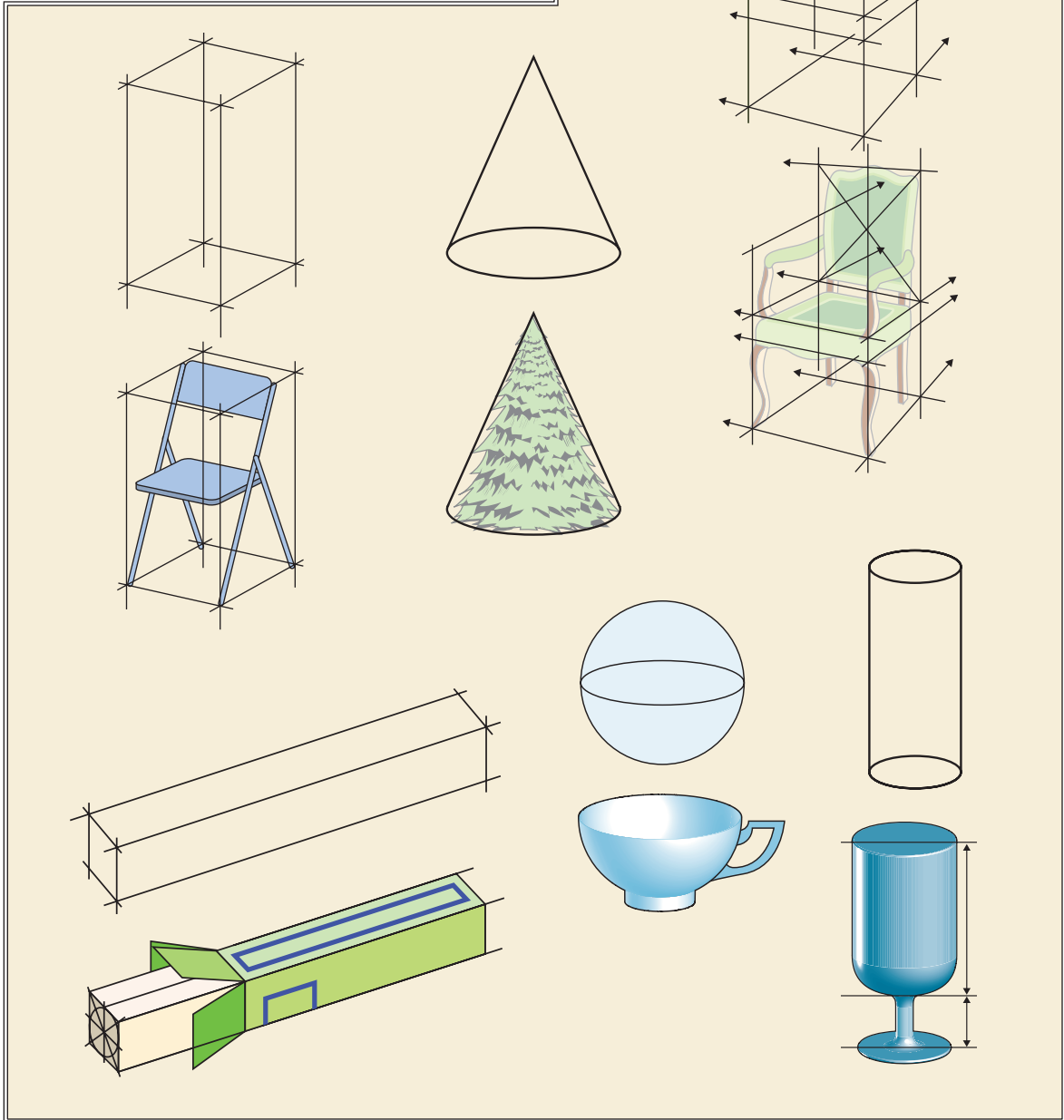

Copyright © by The McGraw-Hill Companies, Inc. All rights reserved.

Using a Protractor

The protractor is used for measuring angles.

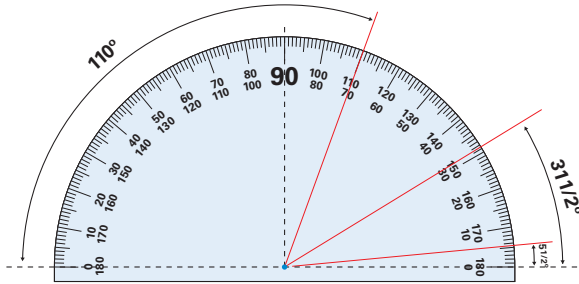

Drawing to Scale

Some objects cannot be drawn full-size. They are too big or too small. For this reason they are drawn smaller or larger than actual size. A building, for instance, may be shown on a map $\frac{1}{6}$ size. Drawing objects larger or smaller than actual size but in the correct proportions is called drawing to scale.

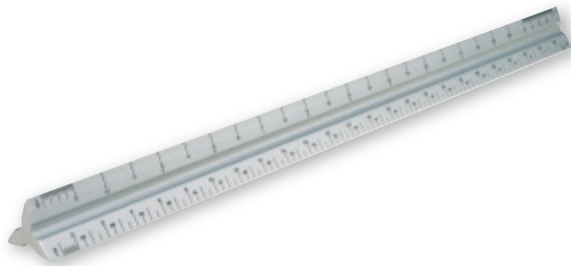

The scale to which a drawing is made should be indicated on the drawing. For example, “Scale: Half size” or “Scale: 1 in. = 1 ft.”

Tools called scales are used by architects and engineers to quickly calculate scale reductions or enlargements. The architect’s scale includes reduced-size scales in which fractions of an inch represent feet.

Dimensioning

Dimensions on a drawing give sizes. They are important when you or someone else must make an object from a drawing. There are many lines and methods used in dimensioning.

You will need to be able to recognize the various kinds of lines. The most important lines are object lines, hidden lines, dimension lines, extension lines, and leader lines.

- Object lines show the visible lines of the object.
- Hidden lines show where a line would be if you could see through the object.
- Dimension lines usually have the dimension written in the center. They end in arrows.
- Extension lines extend from the object to the dimension line and a little beyond it. They show the boundaries of the area being measured.
- Leader lines are usually used to give information or to dimension interior details, like holes. They lead from the dimension to the part referred to. They end in an arrow that touches the part.

All dimension figures should align with the bottom of the drawing. Never place a dimension directly on the object itself unless there is a good reason for it. The largest dimension goes on the “outside” of any shorter dimensions. Diameters of round objects are indicated with a symbol, which means “diameter.” It is written before the dimension number. The symbol for a radius is R. It, too, is written before the number.

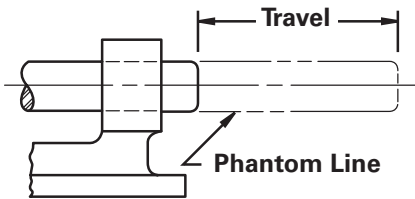
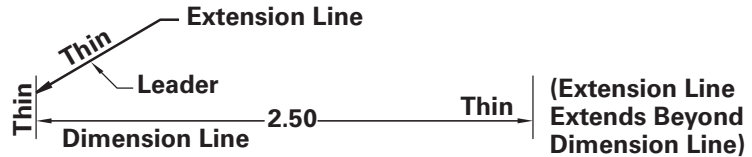
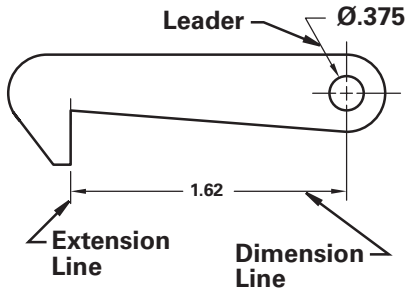
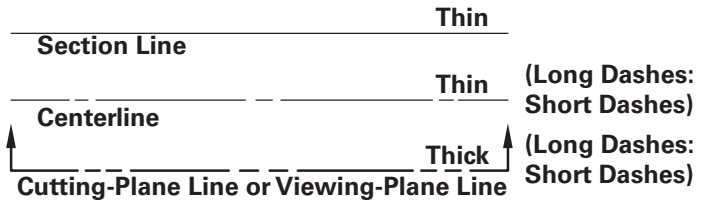
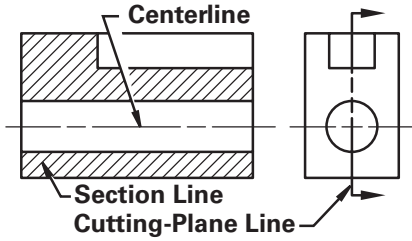
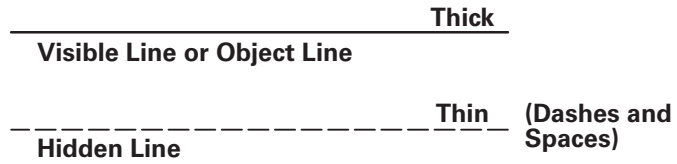
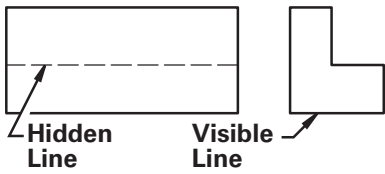

A dimension on a drawing is exact. It is usually not possible to make an object that is exact to within thousandths of an inch. For that reason dimensions are often given tolerances. A tolerance is the amount a given measurement can vary. For example, in the drawing of the five holes, the diameter of each hole must be drilled to a size of .250 inch. With the tolerance given, the holes

could be any size between .255 inch and .245 inch. In other words, there is a tolerance of plus or minus .005 (five-thousandths) of an inch.

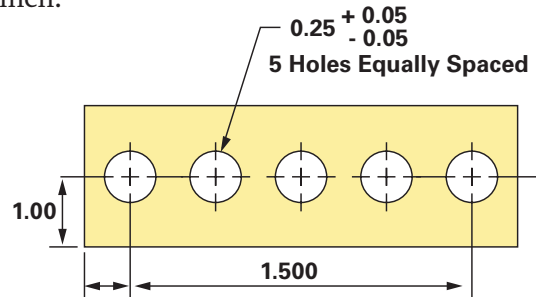

Working Drawings

Working drawings, or multiview drawings, show how to make a product. All dimensions are given. The object is shown from as many angles as needed to indicate its width, height, and depth.

Working drawings show “head-on” views of the top, front, back, sides, and bottom of an object. Ordinarily only three views are

shown—top, front, and right side. They are produced by means of orthographic projection. “Ortho” means straight or at a right angle. In orthographic projection the pictures (views) of the object are of surfaces at right angles to one another.

Working drawings may require dimensioning. Most are drawn to scale. Drawing A shows the steps to follow in making a three-view working drawing.

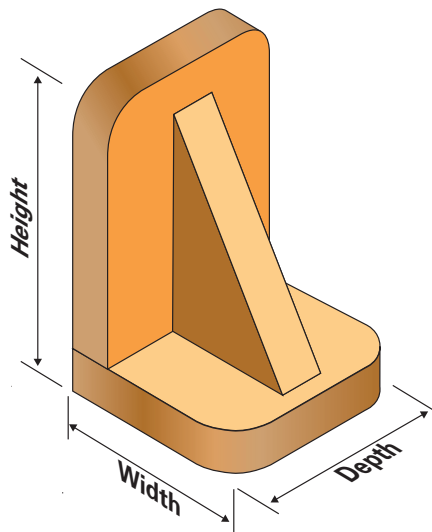

A

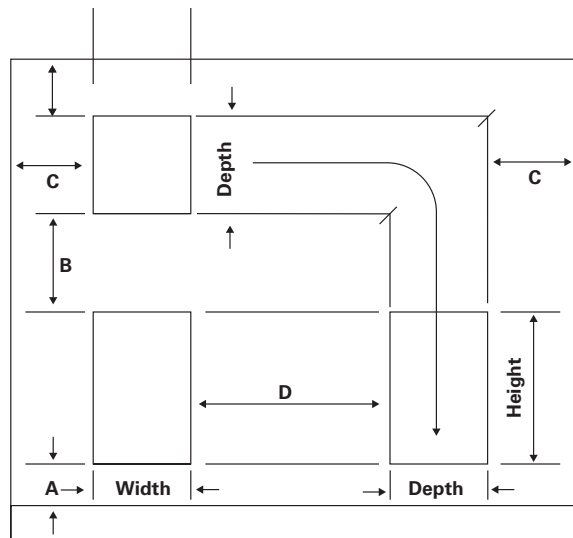

1. Block in boxes for views in proportion.

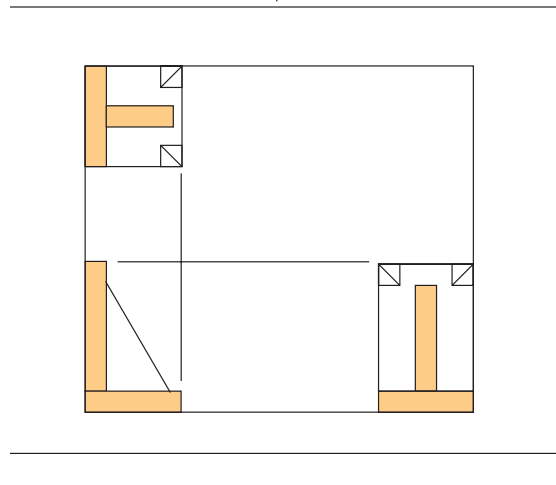

2. Block in construction for arcs, circles, etc.

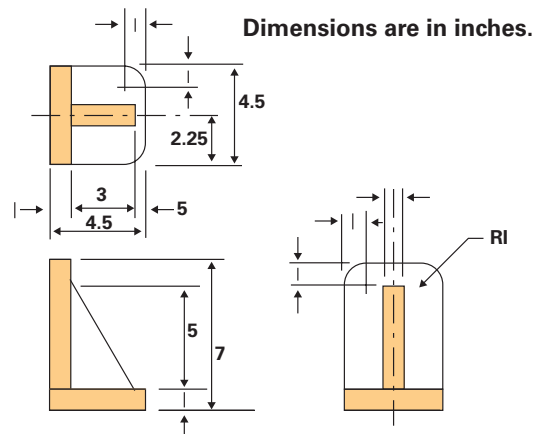

3. Complete details.
4. Add dimensions.

Orthographic projection is used to make a working drawing. Orthographic projection is the technique of showing several surfaces of an object “head on.” Because many objects have six sides, as many as six views are pos-

sible. Usually, however, only three views are shown. These show the front, top, and right side. Note where the observer is standing when viewing the house.

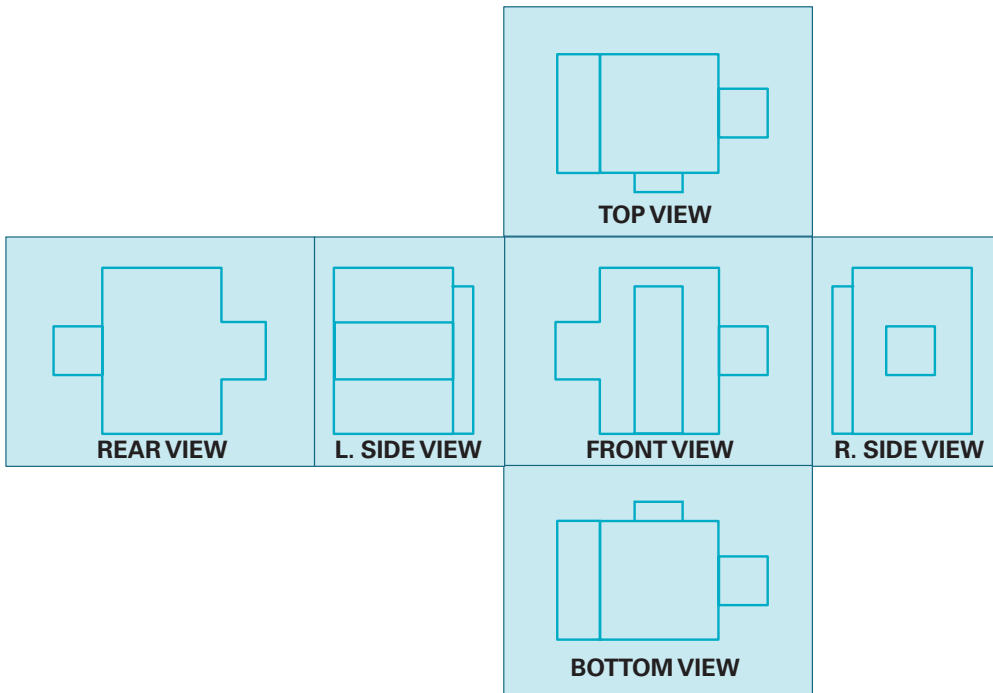
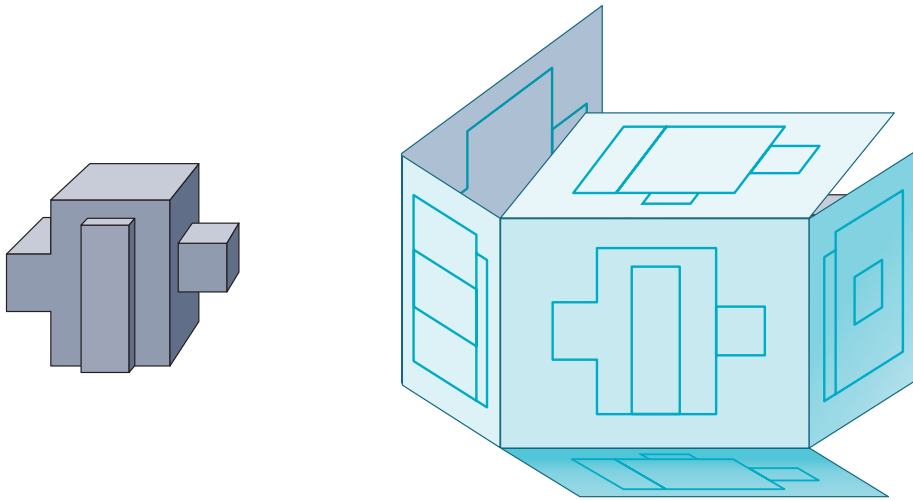

Copyright © by The McGraw-Hill Companies, Inc. All rights reserved.

Engineering Design

Engineering Design Process

These are the main steps in the engineering design process.

1. Define the problem.
2. Brainstorm, research, and generate ideas.
3. Identify criteria and specify constraints.
4. Develop and propose designs and choose among alternative solutions.
5. Implement the proposed solution.
6. Make a model or prototype.
7. Evaluate the solution and any of its consequences.
8. Refine the design.
9. Create the final design.
10. Communicate the processes and results.

Defining the Problem

The design problem must be clearly stated before design work begins. It must include all of the important design requirements. You may need to clarify and restate the design problem. The problem will determine the design.

Checking the Design

Defining and refining the design is just the first part. A good design depends on the proper relationship of several elements. This requires careful planning. A good design depends on good planning. Check the design at each stage to ensure that the design will work.

Elements of Design

The elements of design are the main parts of the design. These elements include:

- **Line.** This can be thin, thick, straight, or curved, among other forms.
- **Shape.** Is it a rectangle, a triangle, or a circle?
- **Mass.** What is the size of the object?
- **Color.** This element can be used to highlight function or add interest.
- **Pattern.** What is the appearance of the object's surface? Is it plain or does it carry a design?

Principles of Design

The effectiveness of a design can be judged against certain principles. These principles include:

- **Balance.** Pleasing integration of various elements.
- **Proportion.** Proper relation of parts to one another.
- **Harmony.** Pleasing arrangement.
- **Unity.** Ordering of parts to create an undivided total effect.

The acronym DEAL is a good way to remember the main steps in the basic problem-solving process.

D: define the problem

E: explore all possible solutions

A: act on the best solution

L: look back and evaluate

MATH

Linear Measurement

A linear measurement is one made along a line. To make a linear measurement, use a rule or a tape measure.

Working with Fractions and Decimals

In the customary system of measurement, you'll often be working with fractions, especially when measuring materials. Most customary rules are divided into inches. A one-foot rule has 12 inches. A yardstick has 36 inches. The inches are divided into smaller parts (fractions). Typically, there are marks to show $\frac{1}{2}$ inch, $\frac{1}{4}$ inch, $\frac{1}{8}$ inch, and sometimes $\frac{1}{16}$ inch.

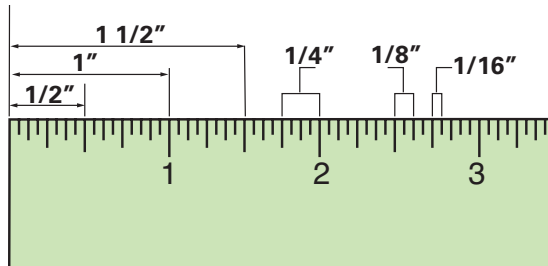
**Adding Fractions**

If the denominators are the same, add the numerators. Simplify the sum if necessary.

Example:

$$\begin{aligned}\frac{1}{8} + \frac{1}{8} &= \frac{2}{8} \\ \frac{2}{8} &= \frac{1}{4}\end{aligned}$$

If the denominators are different, you must rename the fractions with a common denominator before you can add them.

Example:

$$\begin{aligned}\frac{1}{4} + \frac{3}{8} \\ \frac{1}{4} \text{ is equal to } \frac{2}{8} \\ \frac{2}{8} + \frac{3}{8} &= \frac{5}{8}\end{aligned}$$

If the numbers are mixed, add the fractions. (If necessary, rename them with a common denominator first.) Add the whole numbers. Rename and simplify.

Example:

$$\begin{aligned}1 \frac{3}{4} + 2 \frac{1}{2} \\ 2 \frac{1}{2} \text{ is equal to } 2 \frac{2}{4} \\ 1 \frac{3}{4} + 2 \frac{2}{4} &= 3 \frac{5}{4} \\ 3 \frac{5}{4} \text{ is simplified to } 4 \frac{1}{4}\end{aligned}$$

Subtracting Fractions

If the denominators are the same, subtract the numerators.

Example:

$$\frac{3}{8} - \frac{2}{8} = \frac{1}{8}$$

If the denominators are different, you must rename the fractions with a common denominator before you can subtract them. Simplify if necessary.

Example:

$$\begin{aligned}\frac{5}{16} - \frac{1}{8} \\ \frac{1}{8} \text{ is equal to } \frac{2}{16} \\ \frac{5}{16} - \frac{2}{16} &= \frac{3}{16}\end{aligned}$$

If the numbers are mixed, subtract the fractions. (If necessary, rename them with a common denominator first.) Subtract the whole numbers. Rename and simplify.

Example:

$$\begin{aligned}4 \frac{1}{8} - 2 \frac{1}{16} \\ \frac{1}{8} \text{ is equal to } \frac{2}{16} \\ 4 \frac{2}{16} - 2 \frac{1}{16} &= 2 \frac{1}{16}\end{aligned}$$

Multiplying Fractions

Multiply the numerators and then multiply the denominators. Simplify if necessary.

Example:

$$\begin{aligned} \frac{2}{16} \times \frac{1}{2} &= \frac{2}{32} \\ \frac{2}{32} &= \frac{1}{16} \end{aligned}$$

If the numbers are mixed, rename them as improper fractions. Then multiply the fractions. Rename and simplify as needed.

Example: Suppose you have $3\frac{1}{4}$ pounds of cement. You need to use $\frac{2}{3}$ of it. How many pounds would that be?

$$\begin{aligned} \frac{2}{3} \times 3\frac{1}{4} \\ \frac{2}{3} \times \frac{13}{4} &= \frac{26}{12} \\ \frac{26}{12} &= 2\frac{1}{6} \end{aligned}$$

Dividing Fractions

To divide by a fraction, multiply by its multiplicative inverse. In other words, invert the fraction and then multiply. Simplify if necessary.

Example: You have a collection of CDs. Each one, in its case, is $\frac{3}{8}$ " thick. If you make a CD holder that is 6" wide, how many of your CDs will fit in it?

$$\begin{aligned} 6 \div \frac{3}{8} \\ 6 \times \frac{8}{3} &= \frac{48}{3} \\ \frac{48}{3} &= 16 \end{aligned}$$

Converting Fractions to Decimals

To convert fractions to decimals, divide the numerator by the denominator.

Example: To convert the fraction $\frac{3}{8}$, divide 3 by 8.

$$3 \div 8 = .375$$

Converting Decimals to Fractions

To convert decimals to fractions, write the decimal as a fraction and simplify.

Example 1:

$$\begin{aligned} .25 &= \frac{25}{100} \\ \frac{25}{100} &= \frac{1}{4} \end{aligned}$$

Example 2:

$$\begin{aligned} .375 &= \frac{375}{1000} \\ \frac{375}{1000} &= \frac{3}{8} \end{aligned}$$

The greatest common factor of the two numbers is 125. Dividing 375 by 125 = 3. Dividing 1000 by 125 = 8.

Angles

An angle is the figure formed when two lines or two surfaces originate at the same point. Angles are measured in degrees. The following drawings show some common angles.

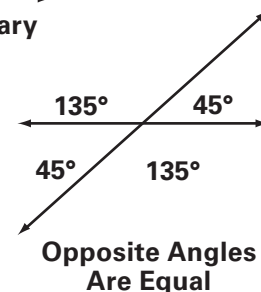
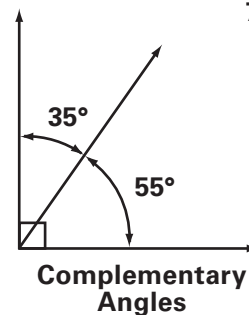
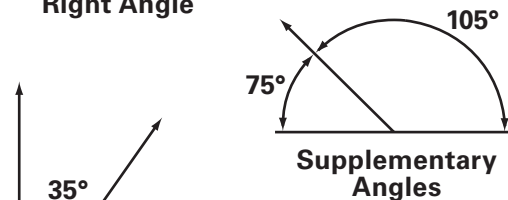
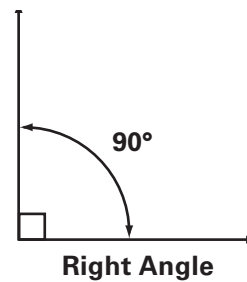

Polygons

A polygon is a closed figure with straight sides. It is classified by the number of sides. In a regular polygon all sides are equal in length and all angles are equal.

3 Sides = Triangle



4 Sides = Rectangle



4 Equal Sides = Square



5 Sides = Pentagon

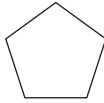

6 Sides = Hexagon

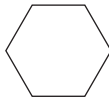

8 Sides = Octagon

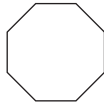

Types of Triangles

Triangles are classified according to the length of their sides.

- **Isosceles.** A triangle having two equal sides.
- **Equilateral.** A triangle having all sides equal.
- **Scalene.** A triangle having three sides of unequal length.

Triangles are also classified according to the size of their largest internal angle. The right triangle has one internal angle of 90°, which is a right angle.

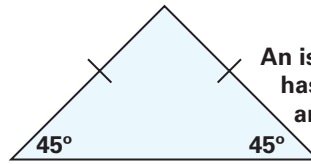

An isosceles triangle has two equal sides and two equal angles.

A scalene triangle has three sides of different lengths and three angles of different sizes.

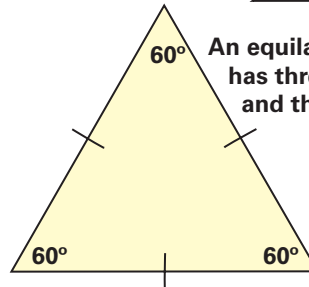
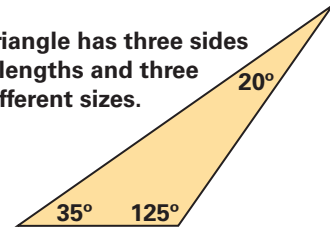

An equilateral triangle has three equal sides and three equal angles.

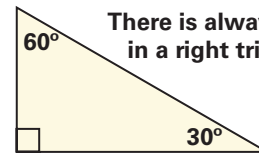

There is always a 90° angle in a right triangle.

Rectangles and Triangles

A rectangle is a four-sided shape with four right angles (90°). The diagonals of a rectangle are always equal. They divide the rectangle into two right triangles. A right triangle has three sides. The longest side is called the hypotenuse. These facts are important when laying out a perfect rectangle. It can be used when constructing a simple box or even when laying out a large building.

$$A^2 + B^2 = C^2$$

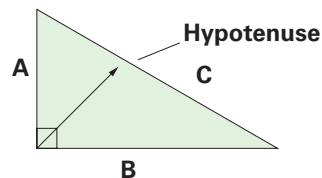

Using Right Triangles

If you know the length of two sides of a right triangle you can figure the length of the third side by using the equation:

$$a^2 + b^2 = c^2$$

c = the hypotenuse, the side opposite the right angle

a and b = the two other sides

This equation is called the Pythagorean theorem. Here's a practical application. Let's say you want to build a storage shed that is $6' \times 8'$.

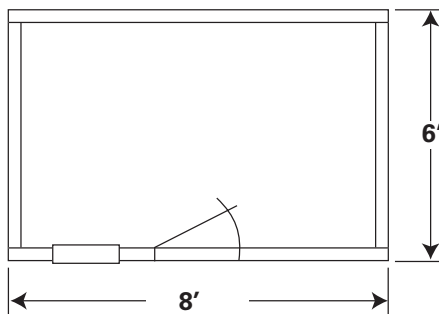
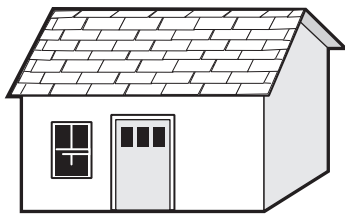

1. First establish the 8' side of the shed. Place a stake in the ground at each end of this side.

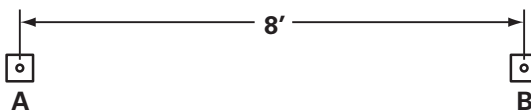

2. Using a calculator, enter 6. Then push the x^2 key. If you do not have that key, multiply 6×6 . The result should be 36. Write down the answer or store it in the calculator's memory.
3. Repeat Step 2 using the 8' dimension.

4. Add the answers from Steps 2 and 3. It should be 100.
5. With the answer of 100 still showing, press the square root key. The answer should be 10. This is the length, in feet, of the diagonal for your shed.
6. From the stakes you placed in Step 1, and using two tape measures, measure 6' from one stake and 10' from the other stake. Where the two measures intersect is where one of the back corners of the shed is located.

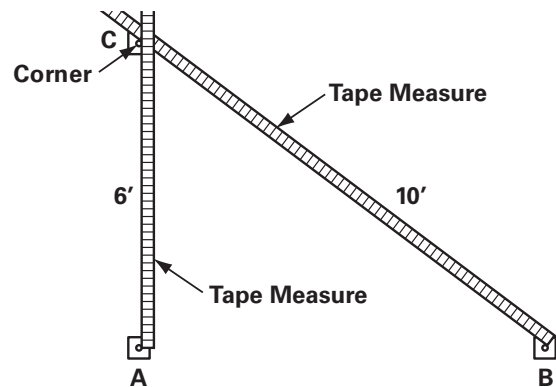

7. Repeat Step 6 from the other stake on the 8' line. Because diagonals of a rectangle are equal, you will have the layout of a perfect rectangle for your shed.

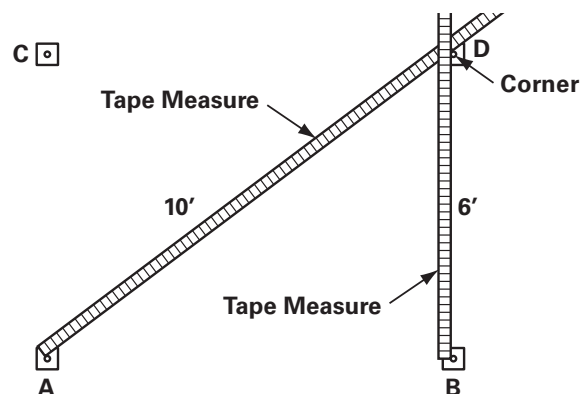

Surface Measurements

Surface measurements measure either the distance around a shape or the area that the shape covers.

Perimeter of a Rectangle or Square

The perimeter of a rectangle or square is the sum of all the sides. Since rectangles have two pairs of equal sides, you can find the perimeter (P) by adding twice the length (l) plus twice the width (w).

$$P = 2l + 2w$$

This formula works also for a square, but there's a simpler way to find the perimeter of a square. All four sides of a square are of equal length. Multiply one side by 4.

Area of a Rectangle or Square

To find the area (A) of a rectangle or a square, multiply one side (length, or l) by an adjacent side (width, or w). **Note:** Area is measured in square units.

$$A = lw$$

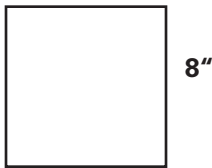

Circumference of a Circle

The circumference is the distance around a circle. To find the circumference (C) of a circle, multiply the diameter (d) by the value of π , which is 3.14.

$$C = \pi d$$

The diameter of a circle is equal to twice its radius. You can also find the circumference if you multiply twice the radius (r) by π .

$$C = 2\pi r$$

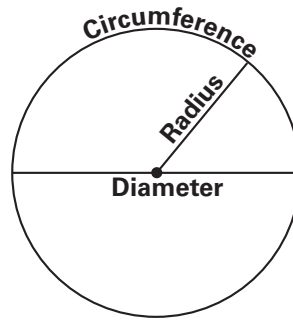

Area of a Circle

To find the area (A) of a circle, multiply π by the radius (r) squared.

$$A = \pi r^2$$

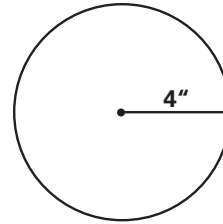

Perimeter of a Triangle

To find the perimeter of a triangle, add the lengths of the three sides.

$$P = a + b + c$$

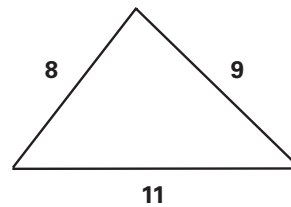

Area of a Triangle

The area (A) of a triangle is one-half the product of the base (b) and the height (h).

$$A = \frac{1}{2}bh$$

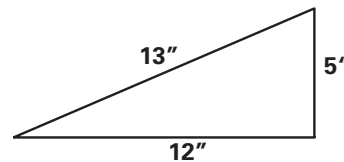

Volume Measurements

Volume measurements measure the space inside three-dimensional shapes. Volume is measured in cubic units.

Volume of a Rectangular Prism

To find the volume (V) of a rectangular prism, multiply the length (l), the width (w), and the height (h).

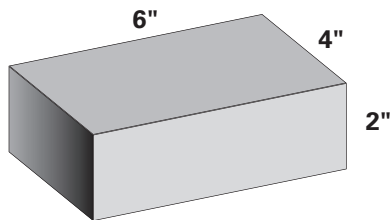

$$V = lwh$$

Volume of a Cylinder

The base of a cylinder is a circle. To find the volume of a cylinder, multiply the area of the circular base by the height. (Remember, to find the area of a circle, multiply π times the radius squared.)

$$V = \pi r^2 h$$

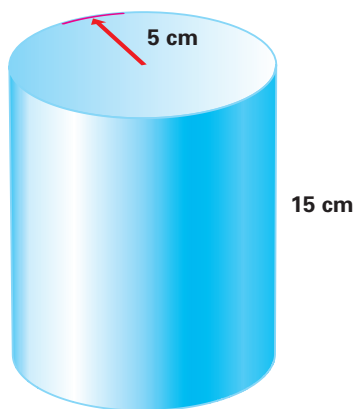

Ratios

A ratio is a way to compare two numbers, using division. For example, directions for mixing concrete may call for 120 pounds of sand and aggregate and 20 pounds of portland cement. The ratio of sand-aggregate to cement can be expressed as 120:20 or 120/20.

The ratio from this mix yields about one cubic yard of concrete. To find the right amounts to make 5 cubic yards of concrete, multiply both terms of the ratio by 5.

$$\begin{aligned} 120 \times 5 &= 600 \text{ pounds sand-aggregate} \\ 20 \times 5 &= 100 \text{ pounds cement} \end{aligned}$$

To make a smaller batch—say, one-tenth of a cubic yard—divide both terms of the ratio in the same manner.

$$\begin{aligned} 120 \div 10 &= 12 \text{ pounds sand-aggregate} \\ 20 \div 10 &= 2 \text{ pounds cement} \end{aligned}$$

The three ratios presented here are equivalent ratios. This is easy to see when you work the ratios as division problems.

$$\begin{aligned} 120 \div 20 &= 6 \\ 600 \div 100 &= 6 \\ 12 \div 2 &= 6 \end{aligned}$$

It's useful to reduce equivalent ratios to their simplest form. This means dividing until there is no number except one that goes into both terms evenly. Both terms of the ratio 12/2 can be divided by 2. To find the simplest form of 12/2, divide:

$$\begin{aligned} 12 \div 2 &= 6 \\ 2 \div 2 &= 1 \end{aligned}$$

The simplest form of 12/2 is 6/1. Knowing the simplest form makes for the easiest conversions. With the concrete mix, we can say simply that a batch of any size needs a ratio of six parts sand-aggregate to one part cement.

Proportion

Proportion is the relation of one part to another. A proportion is an equality of two ratios. A proportion might be expressed as a is to b as c is to d .

Scale

A scale is the ratio of the number 1 to some larger number. Generally, the larger the second number, the smaller the scale. For example, if 1" on a drawing is the equivalent of 50", that would be expressed as 1:50.

Working with Percentages

A percent is a ratio that compares a number to 100. For example, if 80 percent of household waste is sent to landfills, that means 80 out of every 100 pounds goes to a landfill.

Equations involving percents include the percentage, the base, and the rate. If you know two of these, you can find the third.

$$\text{Rate} \times \text{base} = \text{percentage}$$

$$\text{Percentage} \div \text{base} = \text{rate}$$

$$\text{Percentage} \div \text{rate} = \text{base}$$

Integers

An integer is any of the whole numbers, as shown here on a number line. A fraction, since it is not a whole number, is not an integer. Integers can be positive or negative. Integers to the left of zero on the number line are negative. Integers to the right of zero are positive.

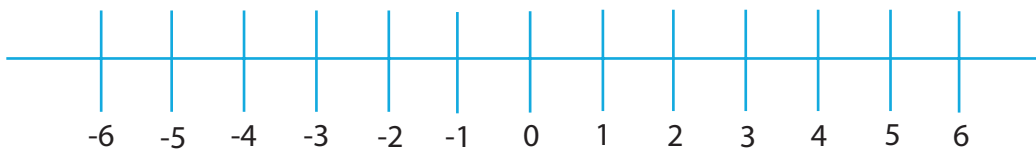

Negative numbers may represent values such as temperatures below zero or a project's costs figured against expected income. Knowing how to solve equations that have negative numbers helps in figuring out the net effect of opposing forces. Examples would include torque versus rolling distance and thrust versus drag.

To make calculations with negative numbers, it is useful to refer to absolute value. The absolute value of an integer is the integer with its plus or minus sign taken away. Absolute value indicates how many steps an integer is away from zero. It is symbolized by a vertical bar before and after the integer. The absolute value of -3 is $|3|$ and the absolute value of $+8$ is $|8|$.

To add integers that are both positive or both negative, add their absolute values and give the sum the same sign as the integers. For example, to add $+8$ and $+4$:

$$\begin{aligned} &+8 + +4 \\ |8| + |4| &= |12| \\ +8 + +4 &= +12 \end{aligned}$$

To add two negative numbers, -5 and -3 :

$$\begin{aligned} &-5 + -3 \\ |5| + |3| &= |8| \\ -5 + -3 &= -8 \end{aligned}$$

To add integers that have opposite signs, find their difference in absolute value by subtracting. Then give the result the same sign as the integer with the higher absolute value. For example, to add $+16$ and -2 :

$$\begin{aligned} &+16 + -2 \\ |16| - |2| &= |14| \\ +16 + -2 &= +14 \end{aligned}$$

After finding a difference in absolute value of $|14|$, we next wanted to attach a plus or minus sign to the answer. We attached a plus because the integer with the higher absolute value, 16, was positive.

As another example, let's add -9 and $+4$:

$$\begin{aligned} & -9 + +4 \\ & |9| - |4| = |5| \\ & -9 + +4 = -5 \end{aligned}$$

Given integers with opposite signs, we subtracted and found a difference in absolute value of $|5|$. To decide whether the answer was plus or minus, we looked to the integer with the higher absolute value, -9 .

Cartesian Coordinates

If you overlay two number lines perpendicular to each other so that they intersect at 0, the result is a Cartesian coordinate system. The usefulness of a coordinate system lies in its ability to express a series of related numbers as a graphic. For example, the work life of a machine tool might be represented as a line that slopes gently and then falls off sharply. This would indicate that the tool has passed a critical point of wear.

The intersection marked zero is called the origin. The horizontal and vertical number lines are labeled x and y , respectively. To plot the points that will form a line or curve, use ordered pairs of coordinates such as $(3, 1)$. The first coordinate, called the abscissa, locates the point horizontally (on the x -axis). The second coordinate, called the ordinate, locates the point vertically (on the y -axis).

In the example, the x -axis might represent the days of operation. The y -axis might show how far from nominal (ideal) the tool is in a particular dimension. Let's say design specifications allow the tool to vary from nominal

by plus or minus one unit. At first the tool measures consistently as 1 unit above nominal. By day 5, the tool has worn down to the nominal measurement $(5, 0)$. On day 6, the tool is still within 1 unit of specification $(6, -1)$, but by day 7 the tool has worn out $(7, -4)$.

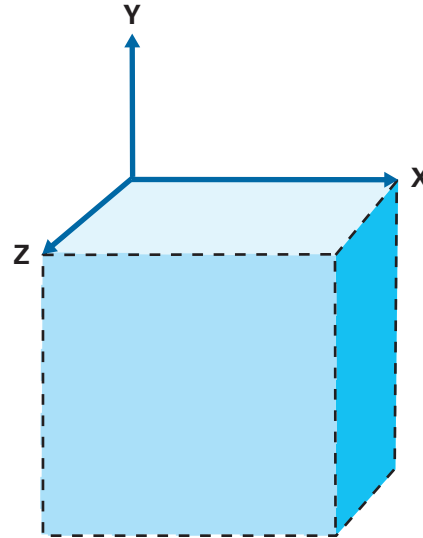

Probability

The probability that a game die will come up 5 on any given roll is $1/6$. Rolling a 5 is one outcome among six possible outcomes. The expression $1/6$ is equivalent to $.17$ and may be stated as “a probability of 17 percent.” A formula for finding the probability (P) of a specific outcome is

$$P = s/t$$

In this formula, s is a specific outcome (rolling a 5) and t is the total number of possible outcomes (the six sides of a die).

The probability formula relies on the assumption that all possible outcomes are equally likely. If the die is weighted on one side, then a factor other than chance will have a decisive effect. Suppose you are calculating the likelihood of rain tomorrow. The nearness of a massive storm would be a fac-



tor other than chance affecting tomorrow's weather. Probability formulas tell you only about the effect of chance on outcomes.

If you flip a true coin five times and it comes up tails every time, people may say that your chance of coming up heads on the next flip has improved. This idea is incorrect. For any one flip of the coin, the probability of coming up heads is always $1/2$, or 50 percent.

Looking at a record of many coin flips, you will find the number of heads to be around 50 percent. As the number of coin flips increases, the percentage for heads will get closer to 50 percent. Probability is a weak predictor for a single event. It becomes powerful when you are looking at a large number of events, such as estimating traffic over a bridge.

Statistics

Statistics is the analysis of data, usually in search of patterns that show trends, cause-effect relationships, or other useful factors. Data refers to numerical measurements. Examples include temperatures, copper prices, and real estate values.

Statistics typically relies on sampling. This is the collecting of a small number of measurements to represent the whole. Television ratings, for example, typically rely on a sample of about one thousand households. Statisticians have ways of confirming that a sample is valid. This is important. The alternative—taking all possible measurements—would be extremely expensive.

The use of statistics is particularly effective in two areas: identifying a norm within the data set and identifying change. Global warming and increased productivity in agriculture are examples of change identified by comparing previous data with current data.

Such comparisons do not necessarily predict the future. However, they do give a basis for making plans.

Identifying the norm helps us understand what is typical in a data set. Statistics uses three concepts for finding mid-range value that is meaningful in a given application. These three concepts are mean, mode, and median.

Mean

The statistical mean, sometimes called the arithmetic average, is the sum of all the values in a data set divided by the number of items in the data set. Using the table of ABC Company sick days as an example, we find the statistical mean to be:

$$51 \div 10 = 5.1$$

The mean gives a representative view when values are well distributed from one end of the range to the other.

Mode

The mode is the value that appears most often in a data set. In the ABC Company data, the mode is 3. Mode is a choice where in-between values obtained by averaging don't make sense, as in the number of children in a household.

Median

The median is the middle number in a data set when the data is arranged in numerical order. In the ABC Company example, the data set would be arranged as follows: 2 2 3 3 3 5 6 8 9 10. Since the data set has an even number of items, average the two middle numbers (3 and 5) and fix the median at 4. The median is the most useful when a few very high or very low values in the data would tilt the average in a misleading way.

ABC Company Workers Out Sick on Each of the Last Ten Workdays	
Workday	Number of Workers Sick
1	2
2	3
3	2
4	5
5	9
6	10
7	6
8	3
9	3
10	8

Using a Calculator

Calculators can help you do math operations faster. Of course, you still need to understand math to know which operations to do. Here are some tips.

- Estimate the answer before you work the problem on the calculator. After you've used the calculator, compare the answer with your estimate. If the two differ, there has been an error. Work the problem again.
- After you have entered the number on the calculator, check the display. If you've made an error, press the "clear entry" (CE) key to remove the number.

- You do not need to enter zero before a decimal point. You do not need to enter final zeroes after a decimal point. Enter the number 0.327000 as .327.
- Remember that the answer displayed on the calculator may not be in its final form. For example, suppose you were solving the problem: \$45 is what percent of \$90? On a simple calculator, the answer would appear as .5. However, you should write this answer as 50 percent. (Recall that a percent is a ratio that compares a number to 100. The answer .5 is 50/100, or 50 percent.)

Metric System of Measurement

Most countries use the metric system. The United States still uses the customary, or standard, system. However, many industries in the United States use the metric system. It is a good idea to learn to use both systems. The modernized metric system is known as the International System of Units. This is sometimes shortened to SI (for *Système International d'Unités*). It uses seven base units. In everyday life, only four units are in common use:

- The meter, the unit of length, is a little longer than a yard (39.37 inches).
- The kilogram, the unit of weight (mass), is a little more than two pounds (2.2 pounds).

Common Metric Units (SI base units are indicated by *)		
Unit	Symbol	Quantity
ampere*	A	Electric current
candela*	cd	Luminous intensity
degree Celsius	°C	Temperature
kilogram*	kg	Weight (mass)
kelvin*	K	Thermodynamic temperature (for scientific use)
liter	L	Liquid capacity (volume of fluids)
meter*	m	Length
mole*	mol	Amount of substance
second*	s	Time
volt	V	Electric potential
watt	W	Power

- The liter, the unit of liquid capacity or volume, is a little more than a quart (about 1.06 quarts).
- The degree Celsius is the unit for measuring temperature.

» This student is using a metric spring scale to weigh an apple. The scale measures weight in newtons (N). The apple weighs about 1 N, or 0.1 kg.



The metric system is a decimal system that uses seven base units. All units larger and smaller than the base units are based on multiples of ten, with no fractions. To indicate these larger and smaller units, prefixes are added to the term for the base unit. For example, larger and smaller units of length are indicated by adding such prefixes as *kilo-*, *centi-*, and *milli-* to the word *meter*. A kilometer is 1000 times larger than a meter.

A centimeter is 100 times smaller than a meter (one-hundredth of a meter). A millimeter is 1000 times smaller than a meter (one-thousandth of a meter). These three prefixes are the most common. They are used for nearly all units of measurement. Both the prefixes and the names of the units can be shortened by using symbols.

Metric-customary conversions are shown in the table on page 608.

Common Metric Prefixes		
Prefix	Symbol	Meaning
nano	n	One-billionth of
micro	μ	One-millionth of
milli	m	One-thousandth of
centi	c	One-hundredth of
kilo	k	One thousand times
mega	M	One million times
giga	G	One billion times

Metric-Customary Conversions

	When you want to convert:	Multiply by:	To find:	
Length	inches	2.54	centimeters	
	centimeters	0.39	inches	
	feet	0.30	meters	
	meters	3.28	feet	
	yards	0.91	meters	
	meters	1.09	yards	
	miles	1.61	kilometers	
	kilometers	0.62	miles	
Mass and Weight	ounces	28.35	grams	
	grams	0.04	ounces	
	pounds	0.45	kilograms	
	kilograms	2.20	pounds	
	tons (short)	0.91	tonnes (metric tons)	
	pounds	4.45	newtons	
	newtons	0.23	pounds	
Volume	cubic inches	16.39	cubic centimeters	
	cubic centimeters	0.06	cubic inches	
	cubic feet	0.03	cubic meters	
	cubic meters	35.31	cubic feet	
	cubic miles	4.17	cubic kilometers	
	cubic kilometers	0.24	cubic miles	
	liters	1.06	quarts	
	liters	0.26	gallons	
	gallons	3.785	liters	
Area	square inches	6.45	square centimeters	
	square centimeters	0.16	square inches	
	square feet	0.09	square meters	
	square meters	10.76	square feet	
	square miles	2.59	square kilometers	
	square kilometers	0.39	square miles	
	hectares	2.47	acres	
	acres	0.40	hectares	
Temperature	Fahrenheit	$5/9 (°F - 32)$	Celsius	
	Celsius	$9/5 °C + 32$	Fahrenheit	

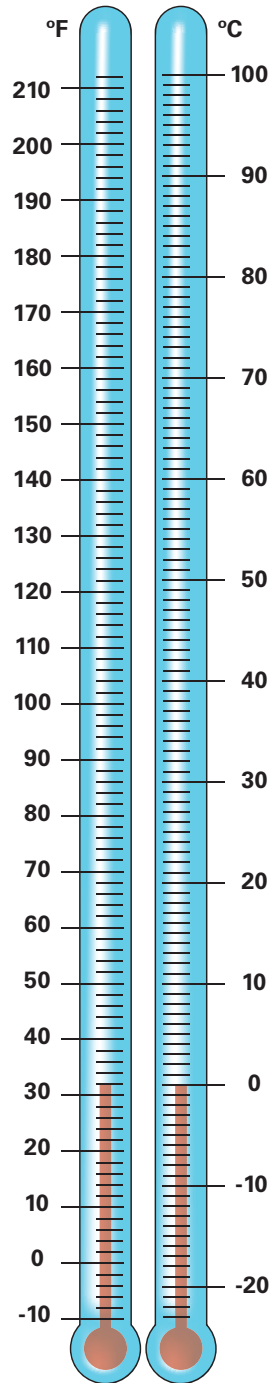

Copyright © by The McGraw-Hill Companies, Inc. All rights reserved.

Weight as measured in standard Earth gravity